

HARVIA

Sauna & Spa

SAUNA

READY MADE SAUNAS,
SAUNA INTERIORS



BATHROOM SAUNAS



INFRARED CABINS
HYBRID SAUNAS



OUTDOOR SAUNAS





1950 - 2020



Enjoy

The sauna is a place for peace and relaxation, where everyone is equal. Going to the sauna with people close to you creates a feeling of togetherness. The sauna is also a traditional healing method that promotes health and well-being. You can get exactly the kind of sauna you want from Harvia.

Make your sauna into an oasis of well-being

We want to create new, relaxing sauna experiences in the midst of hectic everyday life. There you can find harmony of body and mind – on the sauna bench, in the gentle embrace of heat and steam.

Harvia offers everything your sauna needs

A wood-heated sauna by a lake, an electric sauna in a detached house, an outdoor sauna in the city, an infrared cabin in the living room of an apartment, a steam room at a spa, a mobile sauna on the road or...

What is your dream sauna like? Learn more about Harvia's sauna interiors and find your answer.

We will provide you with everything you need for designing and building a sauna – with more than 70 years of experience. In addition to sauna interior models, you can find sauna heaters, safety equipment and sauna accessories in our selection. Our selection also includes bathroom, outdoor, infrared and steam saunas.

Content

<i>Why go to the sauna?</i>	4
<i>Choose a sauna interior to create the perfect sauna just for you</i>	6
READY-MADE SAUNAS	9
<i>Claro</i>	11
<i>Solide</i>	13
<i>Rondium</i>	15
<i>Variant</i>	17
<i>Variant view</i>	19
BATHROOM SAUNAS	21
<i>SmartFold</i>	24
<i>Sirius</i>	26
<i>Capella</i>	27
INFRARED CABINS AND HYBRID SAUNAS	29
<i>Radiant infrared cabin</i>	30
<i>A hybrid sauna</i>	31
OUTDOOR SAUNAS	33
<i>Solide</i>	34
<i>Solide Compact</i>	36
<i>Kuikka and Keitele</i>	38
SAUNA INTERIORS	41
<i>Bench models</i>	42
<i>Panelling material options</i>	44
<i>Bench material</i>	46
<i>Details in Sauna</i>	47
<i>Sauna heaters</i>	48
<i>Sauna heater control units</i>	49
<i>Glass walls and doors</i>	52
<i>Safety equipment and safety switches</i>	54
<i>Sauna lights</i>	56
<i>Accessories</i>	58
<i>Sauna accessories and textiles</i>	60
FOR PROFESSIONALS	63
<i>Sauna and spa solutions</i>	64
<i>A hundred different sauna experiences</i>	66
<i>Beautiful sauna area for a luxury sports centre</i>	67
<i>Floor plans</i>	68





Why go to the sauna?

A sauna is a place to experience dry or wet heat sessions. The steam and high heat help the sauna bathers' mind and body heal and recover.

In Finland, the homeland of Harvia, sauna bathing is a tradition, but more and more people all over the world are interested in sauna and spa experiences. New saunas are built in people's homes, holiday resorts and various community spaces, and no wonder. The sauna relaxes people and increases their well-being.

There are many ways to enjoy the heat in a sauna. Here are three examples of different types of sauna:

- **A traditional sauna;** usually a wood-lined room, heated with a wood-burning or electric heater. The temperature is typically approximately 70–100 °C. Water is often thrown on hot sauna stones; when the water vaporises, it creates a steamy saunabath. Depending on how many stones there are in the sauna heater, the saunabath will be either hot and sharp or moist and gentle.
- **A steam sauna;** it has a steam generator that forms steam in the sauna, so that the humidity in the room reaches up to 100%. In contrast, the temperature is lower than the other types of sauna, roughly 40–60 °C.
- **An infrared cabin,** it has heaters with infrared radiation that warm up the tissues of the body in a targeted way. People sweat more than in a traditional sauna, even though the temperature in an infrared cabin remains under 60 °C. Infrared heaters can also be combined with a traditional sauna.

*Harvia offers you
everything you need
for your sauna.
Contact us:
offers@harvia.fi*

You can find suitable products and interior design solutions for all sauna types in Harvia's selection. We also offer hybrid saunas that combine the benefits of an infrared and a traditional sauna.

Each sauna is unique, designed according to the users' wishes, interior design style and location. You can build a sauna in a separate area reserved for it, or you can put it in a bathroom or in the garden. There are plenty of ready-made options, all of which can also be customised. Let our professionals help you!

The health benefits of the sauna

A traditional sauna has been proven to have many health benefits. The more often you go to the sauna, the better.

- 1. The heat of the sauna is good for your heart.** Going to the sauna 2 to 3 times per week reduces the risk of cardiovascular diseases by more than 20% when compared to people who go to the sauna once a week. The more frequently you use the sauna, the more you can reduce the risk, up to 65%.
- 2. Sauna bathing improves the quality of sleep.** A study on the connection between sauna use and sleep showed that deep sleep increased by over 70% within the first two hours and by 45% within the first six hours. There was a statistically significant decrease in the amount of time spent awake after sauna use.
- 3. Going to the sauna is like exercise.** The heat makes the heart pump more blood, which expands the surface blood vessels, which in turn makes the heart's job easier.
- 4. Sauna bathing improves memory.** Going to the sauna twice a week reduces the risk of dementia by one fifth compared to those who only go to the sauna once a week. Those who go to the sauna 4 to 7 times per week are as much as 60% less at risk of dementia.
- 5. The sauna pampers the skin.** The heat in the sauna multiplies the amount of blood passing through the surface blood vessels, improving the metabolism of the skin. The skin is nourished, retaining moisture more effectively and therefore staying more elastic.
- 6. The sauna cares for the muscles.** The sauna is a good place to relax strained muscles. In addition, going to the sauna before exercise prevents the muscles from becoming sore and increases muscle mobility after the workout.





Exclusive benches

Choose a sauna interior to create the perfect sauna just for you

Modern and simple, or rounded shapes and decorative details? Naturality of wood or an individually selected colour scheme?

Discover the right option for the atmosphere and style you want from Harvia's extensive range of bench and panel designs and other sauna products. Regardless of whether you are building a new sauna or updating the look of your current one.

Decorating the sauna does not have to be a long, stressful project. Harvia's ready-made sauna interior models make the job easy. A ready-made package facilitates the installation and guarantees a stylish and finished end result. You can freshen up the look of the sauna with the smallest details. An elegant finish includes both the sauna heater and its accessories, the lighting, glass doors, bucket and ladle as well as sauna textiles.



Checklist for a small-scale sauna renovation

- **Choose benches and panels** based on the best fit for your sauna. All options are available!
- **Consider the lighting.** You can create the atmosphere you want in the sauna with well-designed lighting. Glass walls and doors also bring in light.
- **Take the intended use into account.** Are there only a few sauna bathers, or do you enjoy the saunabath with a bigger group? Should children or elderly people be taken into account in the design? You can order extra seats and sauna stools and equipment that improves safety as needed.
- **Keep comfort in mind.** Heating the sauna is easy when you choose a heater with a separate control unit, for instance.
- **Finish the transformation with accessories.** Sauna fragrances, textiles and water buckets add a finishing touch to the whole.



The Harvia logo consists of a solid red square with the word "HARVIA" written in white, bold, italicized, uppercase letters inside it.

HARVIA

READY-MADE SAUNAS

Harvia ready-made indoor saunas enhance any space. Our sauna models have it all from heater to panelling and decorative details. Choose from different designs and sizes the indoor sauna that matches your needs. After an easy installation, you can begin enjoying the gentle heat and a state of perfect relaxation. Choose reliable Harvia quality with more than 70 years of experience.





CLARO

Clarify your thoughts

The large transparent glass front of the Harvia Claro gives the sauna a spacious feeling. The outer wall surface is black painted wood board, which creates a beautiful contrast against the light wooden corners.

On the inside, the well-thought balance between light and dark continues in unison with the outer surface. Black spacing between the rectangular panel sheets gives the sauna interior a solid rhythm. The unique Harvia Ventura benches make use of the same design language, adding a bench that is very pleasant to sit on.

Light is one of the key concepts in the Claro sauna. Light comes in through the glass front – and when needed, the corner lamps and a LED strip in the upper bench give their warm-toned support.

Harvia Kivi heater is well suited to the nature of the sauna – the heater produces a traditional soft sauna bath in a modern way. The triangular steel frame with nearly 100 kg of sauna stones looks impressive through the glass front. Also the stylish Harvia sauna accessories set of stainless steel is included in the delivery.



S2121LS





SOLIDE

For those who appreciate design

The Harvia Solide design sauna combines age-old sauna traditions with a fresh and modern design. Featuring a rich combination of pale and black colours, the Harvia Solide design sauna is the perfect fit for new homes. The benches are made from high-quality and moisture resistant GLT (glue-laminated timber) spruce. The surfaces can be treated with tinted sauna finish or wax or left untreated to emphasise their pale spruce colour. The bench options include a continuous bench and single sauna seats that are easy to move. The benches are tailored to the dimensions of the sauna.

The indoor sauna installation package includes wall and ceiling beams with finished wood surfaces, windows, glass doors, a Harvia Virta electric heater and lighting.



S2119LD



RONDIUM

One of a kind

Harvia's Rondium sauna is the perfect choice for bathers who want to pamper themselves. A rounded double door and decorative external stainless-steel soffit with LED lights completes this stylish sauna model. Decorative stainless steel elements in the outside walls create a modern look. Even the base frame is steel covered. This gives a stylish, modern appearance and provides protection from moisture close to the floor. Heat-treated aspen, aspen or alder is used for the exterior panelling. Aspen is used on the interior walls and ceiling.

The tasteful Exclusive sauna interior, with detachable benches, is made of abachi, alder, aspen or heat treated aspen. If Benches are upgraded to Exclusive AIR, available wood materials are alder, aspen or heat treated aspen. The decorative stone wall gives this sauna a stylish contrast. The Topclass Combi is a versatile heater especially for those who enjoy a soft, humid sauna bath with an aromatic atmosphere. The heater is controlled by a digital control unit, which allows you to control the temperature, humidity, and lighting of your sauna.



S2222KL





VARIANT

Create your own oasis

The basic layout of the Harvia Variant sauna is ample and provides you with the opportunity for a variety of different arrangements. The Variant sauna is also the most flexible of Harvia's sauna designs: you have four options (spruce, aspen, alder and heat-treated aspen) for wall and ceiling panelling, and you can choose the windows and the tone of the doors that best match your personal taste.

You can choose the interior design of your Variant sauna from Harvia's three stylish alternatives: Formula, Exclusive or Exclusive Air. A Variant sauna is completely insulated and, therefore, very energy efficient. Metallic corner pieces on the corners of the fascia board give your sauna a distinctive look.

In Harvia Variant sauna you find the cozy, relaxed atmosphere of the original Finnish sauna. The benches and sauna interior are ergonomically designed and follow original Finnish sauna traditions.

The benches, headrests and backrests are made from easy-care abachi wood as standard. High-quality bench design and soft sauna lighting guarantee your enjoyment.



S2020





VARIANT VIEW

Laid back and spacious ambiance

Variant View is designed for unwinding. The benches of Variant View are suited for lying down on your back, allowing an even deeper relaxation. Variant View is also easy to set up and you can choose to install the L-shaped benches either to the left or right side of the sauna.

High quality and large glass walls in the front create an open and spacious ambiance that lets in natural light. Play with colours with the DMX controlled colour lights to create different atmospheres in the sauna.



S1212SV



S1616SV



S1620SV



S2020SV



S1616CV



S2020CV





BATHROOM SAUNAS

A dream of your own sauna is easy to accomplish. True to their name, Harvia's bathroom saunas are designed particularly for humid and small spaces such as the bathroom. The sauna consists of distinct elements, which is why it can be installed easily in the wet room without the help of professionals in just a few hours. There is no need to apply for a building permit, extend your bathroom, modify the ventilation or replace the moisture proofing.



Good to know:

- The small size allows installation in limited space, even replacing a bathtub, for example.
- Assembled from clear elements, the sauna is quick to install.
- No building permit needed. An alteration permit is required for the installation of a bathroom sauna in apartments in housing companies.
- **PLEASE NOTE!** When the bathroom sauna is installed in a washroom (a space with ventilation), separate ventilation is not required for the sauna.
- If the bathroom sauna is to be made a fixed part of the ventilation system, it must be ensured that a separate exhaust ventilation system exists for the space surrounding the sauna.
- The wall elements of the bathroom sauna utilise a water and moisture proofed and thermal insulated panel.
- The sauna heater is connected to a grounded outlet in the bathroom (fuse 16A); an electrician is not needed.
- Further information on the products: www.harvia.fi

A sauna for your current bathroom

A relaxing sauna bath is just what you need after a busy day at work. Resting a moment on the sauna bench gives new strength and a good feeling. A dream of your own sauna is easy to accomplish. True to their name, Harvia's bathroom saunas are designed particularly for humid and small spaces such as the bathroom.

A bathroom sauna fits in your current bathroom. There is no need to extend your bathroom, modify the ventilation or replace the moisture proofing. Bathroom saunas do not require a building permit, because they are considered furniture. An alteration permit is required for the installation of a bathroom sauna in apartments in housing companies.

The bathroom sauna is installed in the wet room. In terms of structure, it is a separate, load-bearing and sealed unit that is not attached to the surrounding structures. The wall elements of the bathroom sauna utilise a water and moisture proofed and thermal insulated panel which serve as a shower room wall without any modifications.

Your sauna is ready for use almost immediately

The bathroom sauna consists of distinct elements, which is why it can be installed easily without the help of professionals in just a few hours. The bathroom sauna is delivered as ready-to-install elements. The delivery includes all necessary parts from wall elements to sauna ladle. The wall elements are lifted to their places one by one, starting from the back wall, the elements are attached to each other, and the seams sealed with silicone. Aside from attaching the sauna heater connector to an earthed wall socket in the bathroom, no electrical work or professional electrical engineer is required. You can install the sauna yourself, or ask for an installation service from your Harvia dealer.

All Harvia bathroom saunas are manufactured at Harvia's sauna factory in Muurame, central Finland. Only high-quality products which have been proven to be good are used in the production. All saunas are inspected before delivery.

Please consider the following in the installation:

- The sauna height is 2,080 mm with adjustable legs. For installation, approximately 100 mm of vertical installation clearance is needed.
- Together with the fibre optic lights, the minimum room height is 2,250 mm.
- Depending on the model, approximately 20 mm of installation clearance should be reserved on the sides and back.
- Please note! The free space is measured from the narrowest place of the bathroom.
- The sauna must be installed in an approved wet area.
- For further information, please refer to the instructions for installation.

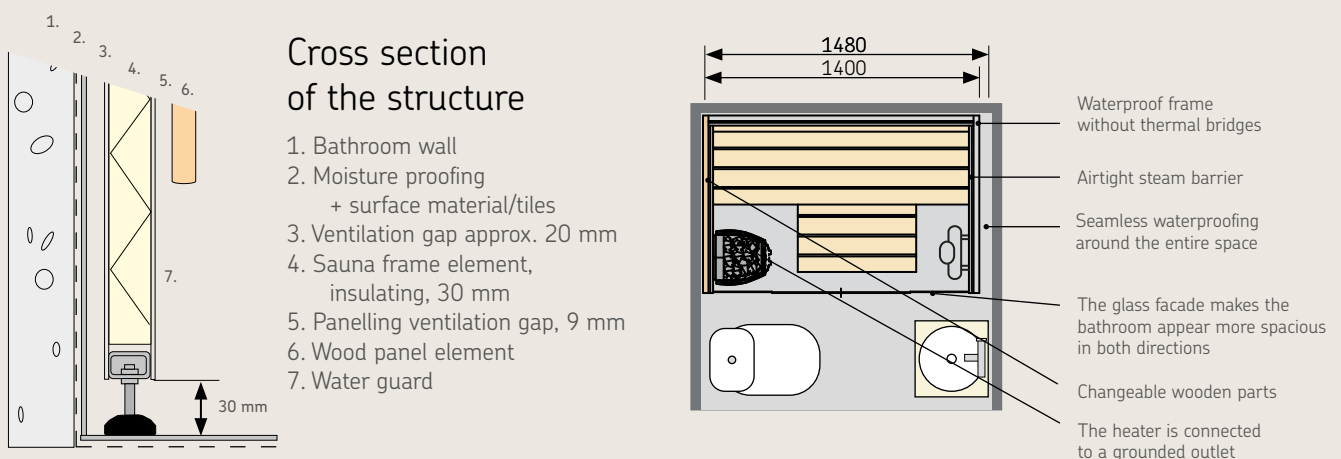



SmartFold

Make effective use of the square meters in your bathroom

Harvia's foldable and adaptable bathroom sauna SmartFold only uses floor space when it is needed. SmartFold is a real lifecycle sauna, suitable for all users during various stages of life.

There is always use for the saved space

When the sauna is folded, you can easily make an open space in the washroom that conforms to the regulations. Compared to a traditional sauna solution, you save up to several square meters of space. Constructing a spacious wet room is relatively expensive, which is why it may be more economical to utilize the saved space in other rooms. Harvia SmartFold allows you to use the bathroom as an efficient utility room. When one half of the floor space required by the sauna can be utilized for other purposes, you will have a nice amount of additional space for a drying rack, iron, or for changing the soil in your potted plants, for example.

Accessible sauna for all users

The saved space makes the everyday life of a young family easier, and the solution also pays attention to accessibility and older users. When the benches are left folded up, the sauna can be accessed with a wheelchair, and if climbing to sit on the benches of a regular sauna is difficult for you, you can leave the upper bench of the SmartFold sauna folded up, and enjoy the heat while sitting on the lower bench.

The heater, designed specifically for this sauna, provides heat from top to bottom. The heater's output is 3.6 kW (230 V 1N~), and you can plug it into the bathroom's grounded power outlet, also giving flexibility to the electrical design. SmartFold is energy efficient: thanks to the moderate heater output and volume, as well as the effective insulation, you can save up to 40 % in electricity consumption, compared to a traditional sauna solution. The safety equipment ensures that the heater only switches on when the sauna is unfolded. Using the folding mechanism is easy, and SmartFold looks stylish, even when it is folded.





Standard scope of delivery:

- Harvia Unio sauna heater
- LED light strip
- Upper covering ribs (heat-treated Aspen)
- Set of sauna accessories, stainless steel (incl. water bucket, ladle, thermometer/hygrometer).
- Bench material: heat-treated aspen, panelling: aspen STP 70x15

Additional options

- panelling boards (heat-treated aspen)
- wall-mounted handrail
- additional handrail outside the sauna

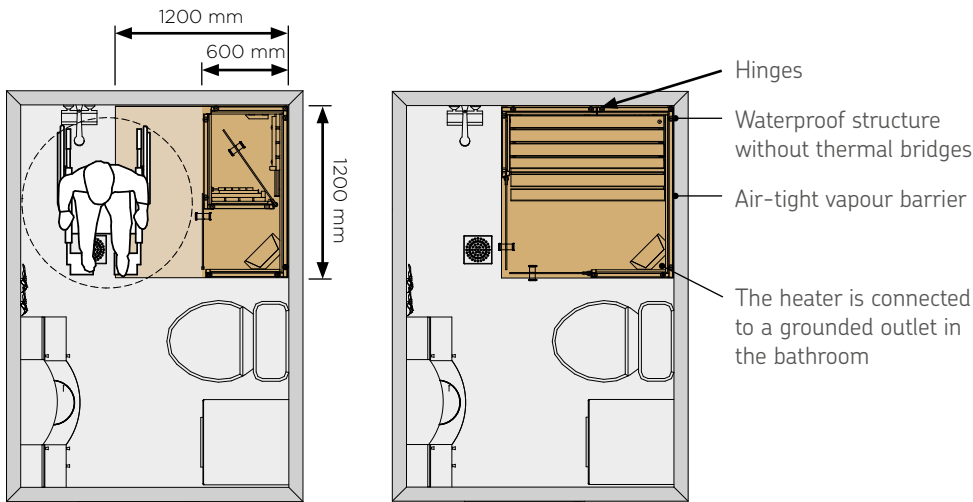

SF1212L

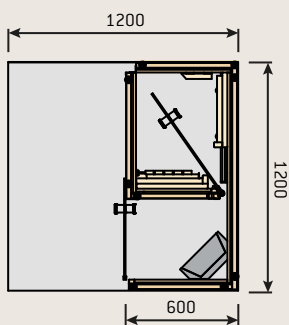

SF1212R

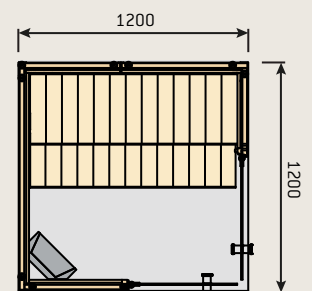
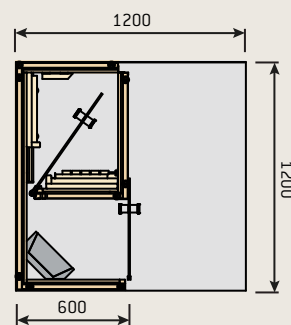
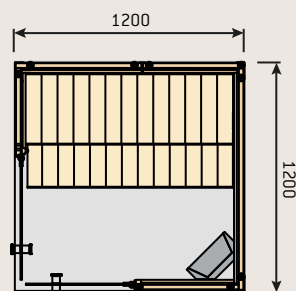

Sirius

Harvia Sirius is a stylish and modern bathroom sauna model with plenty of glass surface at front. The width of the bench is over 100 cm in each model, so there is room for two persons to relax and enjoy the sauna bath of Harvia Vega Compact heater.

In the standard delivery the Formula sauna interior and panelling are of alder. The Formula sauna interior is available also in aspen. Also Exclusive Air sauna interior model can be selected, the wood material options are aspen, alder and heat-treated aspen. Instead of the standard alder panelling, you can select aspen or heat-treated aspen.

The stylish Harvia sauna accessories set of stainless steel is included in the delivery. Tall, modern door handle gives the finishing touch for Sirius model. Options available: fibre optic lights, upper covering ribs and side cover.



SC1111K

Standard scope of delivery:

- Water and moisture proofed and thermal insulated frame elements
- Frame, white colour
- The Harvia Formula bench, European alder
- Panelling of European alder
- Harvia Vega Compact sauna heater (BC35), 3.5 kW (16A 230V 1N~, earthed 5 m cable, cable coupling), sauna stones
- Glass facade, clear
- Exhaust air vent
- Steel water bucket and ladle, thermo-/hygrometer
- Installation instructions and fastening kits

Additional options:

- The Harvia Formula bench, aspen
- The Harvia Exclusive Air bench, available wood materials: aspen, European alder, heat-treated aspen
- Panelling options: aspen or heat-treated aspen
- Fibre optic lights, 6 light points. Connected to an outlet using its own plug, no switch.
- **Please note!** Minimum room height 2,250 mm.
- Upper covering ribs, standard height 300 mm.
- Special measurements for the upper covering ribs must be listed in connection with the order. Material same as on the benches.
- Side cover, width 75 mm, white, can be installed on either side of the sauna.
- Glasses in a shade of bronze

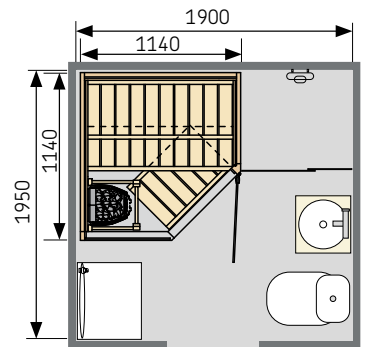

Example of placing Sirius SC1111K into the bathroom

Harvia Sirius, straight and corner model

Sauna height: 2,080 mm.

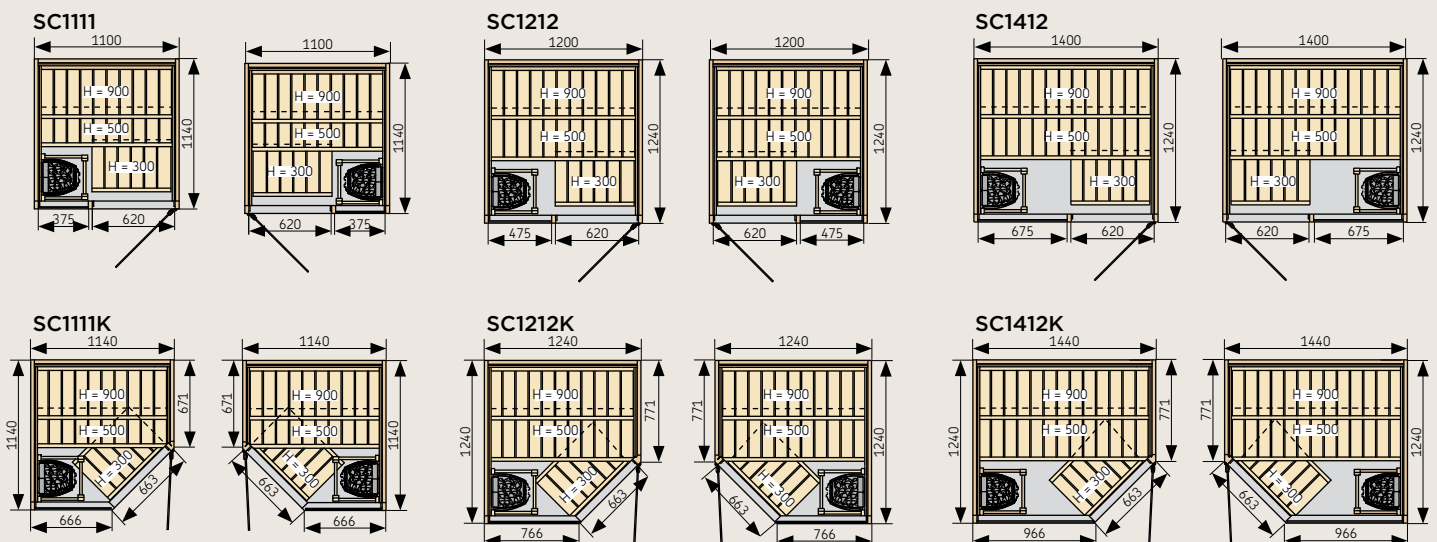

Capella

The Harvia Capella bathroom sauna for two is an ideal solution for a small bathroom, adding a touch of luxury while taking up no more space than a standard bathtub. To a space requirement even 145 x 90 cm is enough.

Capella bathroom sauna's benches, stool and panelling are of alder. The Harvia Capella bathroom sauna model is equipped with space saving sliding doors, giving the sauna a modern appearance and bringing a feeling of space to the bathroom.

The sauna is also available as a mirror image. Please specify the desired layout when ordering (sauna heater on the left/right).



SC1409

Standard scope of delivery:

- Water and moisture proofed and thermal insulated frame elements
- Installation frame
- Frame, white colour
- Bench model and panelling of European alder
- Harvia Vega Compact sauna heater (BC35), 3.5 kW (16A 230V 1N[~], earthed 5 m cable, cable coupling), sauna stones
- 4-part sliding doors, clear glass
- Exhaust air vent
- Steel water bucket and ladle, thermo-/hygrometer
- Installation instructions and fastening kits

Additional options:

- Fibre optic lights, 6 light points. Connected to an outlet using its own plug, no switch.
- Please note! Minimum room height 2,250 mm.
- Upper covering ribs, standard height 300 mm.
- Special measurements must be listed in connection with the order.
- Material same as on the benches.
- Side cover, width 75 mm, white, can be installed on either side of the sauna.
- Glasses in a shade of bronze

Harvia Capella

Sauna height: 2,080 mm.

SC1410

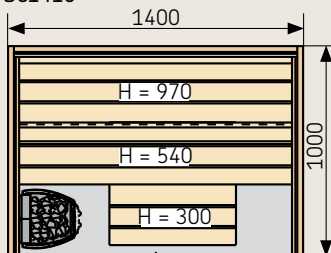

SC1409

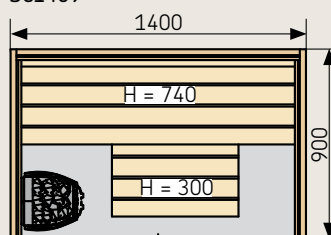





INFRARED CABINS AND HYBRID SAUNAS

We have combined Finnish design with innovative infrared technology with health benefits in a form that is easy to assemble. Harvia infrared cabins bring luxurious well-being to homes, spas, fitness centres and wherever people want to experience a perfect harmony of body and mind

Radiant infrared cabin

The warmth of the infrared cabin is based on heat radiator elements that produce dry long-wave heat. It reaches deep in the tissues, which has several positive effects. The heat is of the same good kind as that produced by the sun, which is why the effects of the infrared cabin and bright light equipment are similar.

Invest in yourself – your health and well-being

Infrared heat is used as a treatment in hospitals and wellness centres, because its health effects are acknowledged. The effects of infrared heat are similar to the effects of exercise. It stimulates the blood flow, relaxes the muscles, burns calories, relieves stress and relaxes both physically and mentally. Because infrared heat energises and accelerates vital functions, it also serves as an excellent form of warming up before exercise. After exercise, the heat has reviving and relaxing effects.

The Harvia Radiant infrared cabin can be used every day. The suitable duration of one use is approximately 30 minutes. The temperature can be adjusted to a maximum of 65 degrees. In order to maximise the benefits of the infrared cabin's wide range of positive effects, Harvia recommends using the infrared cabin approximately three times per week. The higher temperatures of the infrared cabin cause increased sweating, so remember to drink water before and after use.



SGC1210BR



SGC0909BR

Quick instructions for the users of the Radiant infrared cabin:

- Protect the benches and floor of the infrared cabin with a towel. The infrared cabin causes increased sweating, so the benches and floor should be protected from the moisture exuding from the skin.
- Keep the air inlets open during use. Efficient air flow ensures that the heat elements stay on all the time, creating more good heat.
- The infrared heat works best on bare skin. Wearing a towel, for example, partially prevents the good heat from being transferred to your tissues.
- Drink plenty of water. The dry heat of the infrared cabin evaporates plenty of liquid from the body.
- A suitable duration of one use is approximately 30 minutes.
- Take something to read, and put your favourite music on in the player. Reserve a moment for relaxation.
- Enjoy the pleasant warmth

SGC0909BR

- 4 heating elements
- room for one person
- size 900 x 900 x 1,910 mm (width x depth x height)
- weight 82 kg
- Power 1,340 W
- fuse size 10A, earthed wall socket

SGC1210BR

- 5 heating elements
- room for two persons
- size 1,200 x 1,050 x 1,910 mm (width x depth x height)
- weight 117 kg
- Power 1,820 W
- fuse size 16A, earthed wall socket

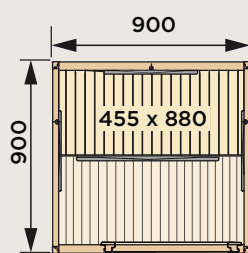

SGC0909BR

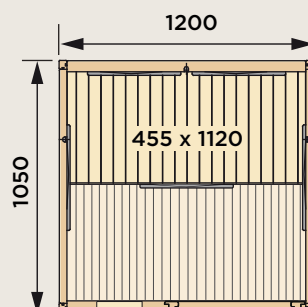

SGC1210BR



Hybrid sauna with Solide benches and transparent white spruce panelling

A hybrid sauna

A hybrid sauna refers to the combination of a traditional sauna and infrared cabin in the same space. Converting an existing sauna into a hybrid sauna is easy and affordable. Talk to a Harvia sauna designer, when you want to turn your sauna into a modern hybrid sauna with health benefits.

Hybrids combine the health effects of the sauna with infrared heat

Infrared warms the muscles and body quickly and more efficiently than a traditional sauna, while the higher temperature of the traditional sauna ensures a gentle bathing experience.

The maximum bathing temperature of a hybrid sauna, where the bather enjoys the sauna heater warmth at the same time with the infrared heat, is 70 degrees. If you desire a higher temperature bath, you can turn off the infrared radiators. If the bather only wants the relaxing infrared treatment, they can select infrared as the bathing form. The hybrid sauna combines all forms of sauna bathing in one wellness oasis.

! You can find more information about hybrid saunas at www.sentiobyharvia.fi

SENTIO BY HARVIA







OUTDOOR SAUNAS

Make your yard into the best place for your entire family to spend time in by adding an outdoor sauna. In an outdoor sauna, you can enjoy a modern cottage feel and spend the summer relaxing with the people close to you. You can also build a pleasant comfort zone around the sauna, equipped with an outdoor kitchen, a hot tub or a jacuzzi. The style of Harvia's design saunas also fits in well with the look of new residential areas.



Solide

A new dimension to your home

The Harvia Solide design sauna provides you with a new way of enjoying your home. This unique design sauna is much more than an ordinary yard sauna. The sleek and simple design also fits in well with the look of new residential areas. You can paint the exterior of the sauna to match the colour of the house. The Harvia Solide design sauna is available in three sizes, which allows you to choose the solution most suitable for your yard.

For those who appreciate design

The Harvia Solide design sauna combines the age-old sauna tradition with a fresh and modern design. In this design sauna, the heater chamber is filled with wood from the outside, which allows the chamber to be used as a fireplace on the other side. The Duo glass wall, made of translucent white satin glass, serves as a beautiful interior element in the Harvia Solide design sauna while also transmitting light and warmth from the sauna to the sitting room.

Frame ready in just one day

The Harvia Solide design sauna is an effortless solution. The design sauna is delivered as a ready package that is easy to erect, and the only thing missing is the foundations. When the sauna is erected by building professionals, you can have it ready in your yard in just one day.

Contact the building authority in your municipality or city in matters pertaining to building permits or ask us for more information!

Select the option most suitable for you

Solide Outdoor 1
SLD01PS

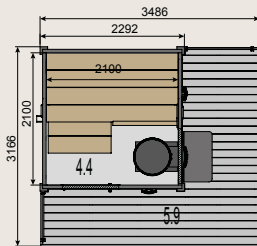

Solide Outdoor 2
SLD02PS

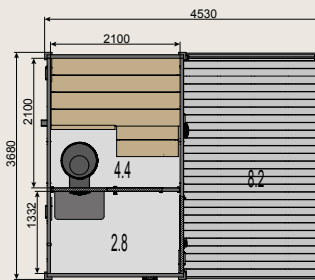

Solide Outdoor 3
SLD03PS

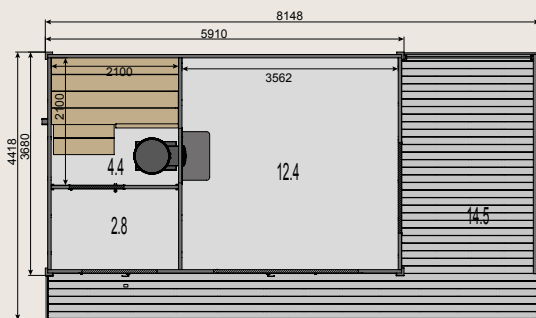

Standard scope of delivery

- Walls
- Sauna floor
- Tongue-and-groove board roof
- Windows and doors
- Sauna interior (Solide or Scala)
- Legend 240 Duo heater
- The scope of delivery includes fastening kits and adhesive compound

- Tools that you will need include: a cordless drill, a silicon extractor, a carpet knife, a saw, sandpaper, a hammer, a hacksaw, an angle grinder (not included in delivery)
- Permits and foundations as well as drainage and electrical wiring design are not included in the delivery
- The roof surface material and terrace are not included in the delivery, but are available as options

For more information, visit harvia.com



Solide Compact

A cottage feel in your own yard

The Harvia Solide Compact outdoor sauna is designed by Vesa Vehmaa, manager of the Harvia sauna factory. The sauna combines the Finnish sauna tradition with modern Scandinavian design. The conveniently sized design sauna brings a cottage atmosphere to your yard, even in a big city. You can build a pleasant comfort zone around the sauna, equipped with an outdoor kitchen, a hot tub or a jacuzzi.

The sleek and simple design of the Harvia Solide Compact outdoor sauna also fits in well in a modern environment. The stylish outer surfaces are made of light-coloured spruce. The outdoor sauna accommodates three to four people. The design sauna is delivered as a complete package that is easy to erect, and the only thing missing is the foundations.

Solide Compact

SLDC02PS

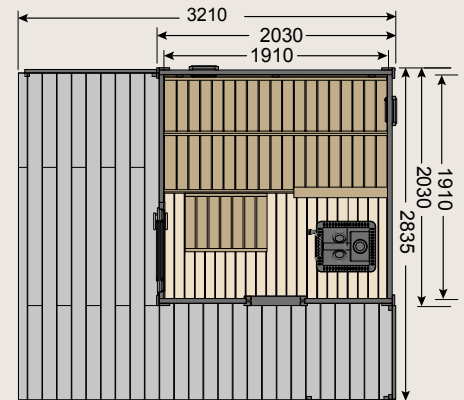
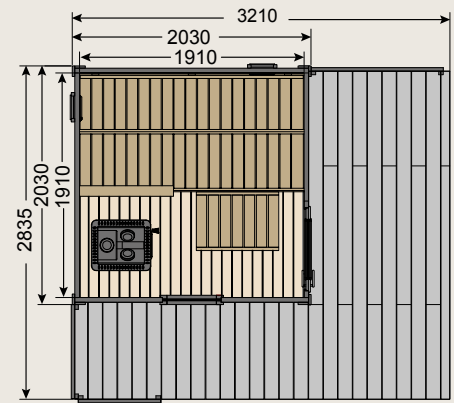
**Delivery contents****Floor:**

- floor beams made of weather-resistant planks
- floor boards: 80x19 mm, spruce
- floor beam strength 40 mm, spruce
- outer corner boards 80x20 mm, spruce

Walls:

- material: planed spruce, thickness 40 mm
- planed exterior and interior
- corner boards, untreated spruce

Ceiling and roof:

- ceiling beams 130x40 mm, spruce
- ceiling boards, spruce
- roof, tongue-and-groove boards
- fascia boards
- Fastening supplies: pins, insulation fill and bitumen putty

Terrace:

- load-bearing frame beams and terrace boards
- protective grating, untreated spruce (2 pcs tall, 1 pc low)

Sauna:

- spruce benches (upper bench, lower bench, footstool, footrest, backrest)
- the delivery also contains bench supports and fastening supplies
- sauna window with a wooden frame, insulated glass element
- front door with a wooden frame and insulated glass (lockable door)
- ventilation hatches (2 pcs) and ventilation grills (2 pcs)



Kuikka and Keitele

Enjoy nature

Harvia sauna – genuine Finnish sauna enjoyment. The feeling of the open air on your skin. A combination you have to experience! For centuries in Finland the sauna was a separate building with its own unique features.

Now you can experience the same atmosphere with Harvia Outdoor sauna models: Kuikka and Keitele.

The Harvia Outdoor sauna package delivery is much more than just the sauna building itself! The delivery package includes all the necessary wood, roof and fastening materials and, according to your choice, a woodburning sauna stove with steel chimney or an electric sauna heater.

Whether next to your swimming pool, in your green garden or in the middle of a humming forest, a Harvia Outdoor sauna offers you authentic, peaceful moments of enjoyment.

Kuikka
S02200

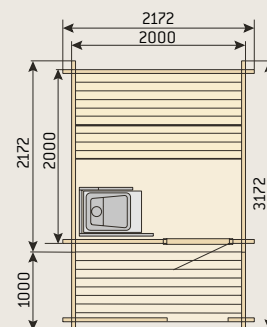

Keitele
S04000

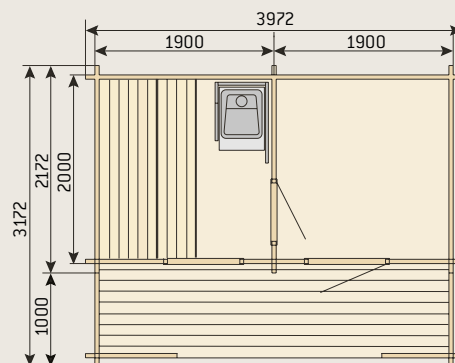



**HARVIA****SAUNA INTERIORS**

Our sauna interior packages complete your sauna. You can choose from seven interior alternatives: Exclusive, Exclusive Air, Ventura, Solide, Scala, Solar and Formula. Add the finishing touches to the whole by paying attention to the large and small details of the sauna interior. Harvia's broad range of products offers everything from high-quality heaters to safety equipment, from glass doors to buckets, and from thermo-hygrometers to sauna fragrances.

Furnish your sauna according to your own taste

Bench models

Harvia's sauna interior packages include benches, backrests and other elements to complete your sauna. You can choose from seven interior alternatives: *Exclusive*, *Exclusive Air*, *Ventura*, *Solide*, *Scala*, *Solar* and *Formula*.



Exclusive

The Scandinavian design of Exclusive benches represents subtle elegance while also being practical. The Exclusive sauna interior model is also well-suited for large saunas, because it is designed to withstand continuous, heavy-duty use. The longitudinal boarding of the benches highlights the sleek look, is comfortable to sit on and minimises exposure to moisture. The detachable bench covers facilitate cleaning and installation. The material options include alder, abachi, aspen and heat-treated aspen. The backrests and bench surrounds are made of the same wood material as the benches.



Exclusive Air

The Exclusive sauna interior model is also available with narrower battens, which further emphasise the airiness and sleekness of the design. The middle sections of the bench covers, the backrests and the bench surrounds are made of narrower, 28-mm-wide material. The available materials include alder, aspen and heat-treated aspen.

We tailor the dimensions, shapes and panelling of the benches to suit each customer's specific needs. The sauna heater, lighting and interior decoration are also designed and implemented down to the smallest details for a perfect solution based on your wishes.



Ventura

Something completely new for your sauna! Ventura's benches, backrests and bench surrounds are made of form-pressed veneer glued in layers. The rounded finish makes sitting on the benches very pleasant. Lamps are integrated in the backrests.

The Ventura sauna interior model is made out of fuma wood. As a material, fuma is very well suited for benches, because it retains its light colour well and is highly resistant to both heat and moisture fluctuations. We recommend paraffin oil treatment for the benches.

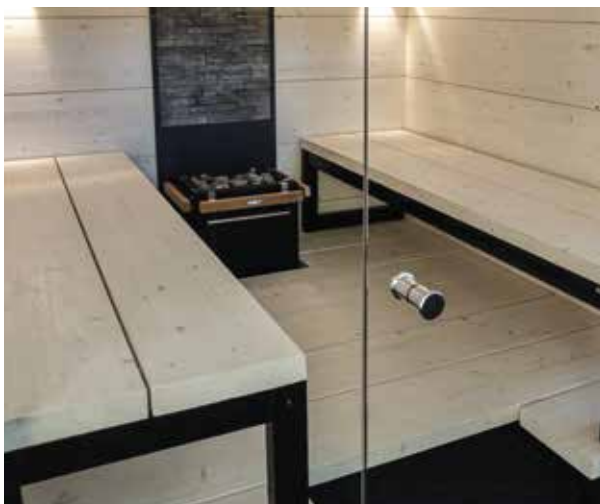

Solide

The Solide bench package combines age-old sauna traditions with a fresh and modern design. The sleek and simple design features a rich combination of pale and black colours, which fits in well with the look of new homes. The surfaces can be treated with tinted sauna finish or wax or left untreated to emphasise their pale spruce colour. The bench options include a continuous bench and single sauna seats that are easy to move. The benches are tailored to the dimensions of the sauna.



Scala

Harvia Scala is a different and straightforward bench solution for middle-sized or large saunas. The lower bench spanning from wall to wall and the streamlined upper bench give the sauna a modern look. Instead of fixed upper benches, Scala is also available with separate benches which can be placed freely on the wide lower bench. The material options are aspen, heat-treated aspen, alder and heat-treated pine.



Solar

The Harvia Solar sauna interior model is characterised by its radial corner module. The front of the benches and the backrests feature a thin black stripe as a stylish detail. The available bench material options include abachi, alder, aspen or heat-treated aspen. The backrests and bench surrounds are made of the same wood material as the benches.

If necessary, the benches can be supported with an end support, and there are matching lampshades compatible with Harvia's lamps available for the corners. The bench seats can be removed for cleaning. With the Solar benches, you can add elegance to your sauna interior without forgetting practicality.



Formula

Simple lines, fresh forms. Formula is the right interior for you if you appreciate linear design. The basic Variant sauna package includes the Formula interior made of abachi unless you specifically select another wood material or interior design. Formula uses abachi, aspen, alder or heat-treated aspen as the material for the benches, backrests and bench surrounds.

Panelling material options

The panel boards can be stained with a colour of your liking. Thanks to its light and even colour, aspen panels are best suited for staining.



Spruce, STP 15 x 95

Spruce panelling is slowly grown, healthy and tough Finnish softwood with sound knots that enliven the surface. Spruce secretes very little resin, and the wood retains its light colour for many years. Run: 85 mm.

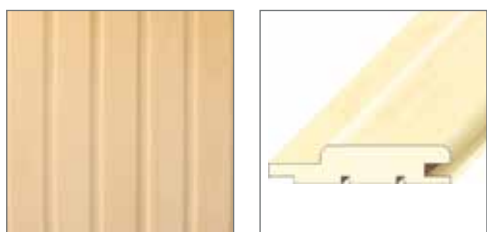

Aspen, STP 15 x 70

Aspen is a traditional sauna material because of its characteristics. Aspen's light and even colour is long-lasting and creates a fresh atmosphere inside your sauna. Run: 60 mm.



Alder, STP 15 x 70 / STS 15 x 120

Alder is a beautiful, reddish-brown hardwood, suitable for benches in saunas for family use. The material requires some care and expands and contracts over the course of time. Run: 60/110 mm.



Heat-treated aspen, STP 15 x 70

Heat-treated aspen preserves its shape well as the years pass. It is the darkest in colour of Harvia panelling material and also has a pleasant scent. You can accentuate the shade of the wood with paraffin oil. Run: 60 mm.



Fuma (Ventura board 300 x 600)

Fuma retains its light colour well and is highly resistant to both heat and moisture fluctuations.



Heat-treated Radiata pine, STS 15 x 140

The Radiata panelling boards are a wide, dark-coloured option that creates a peaceful and elegant look for your sauna. Run: 130 mm.



Effex sauna panel STS 14 x 112 x 2010

ASH High-quality finger-jointed knotless pine panelling surface coloured a translucent shade of grey. The panel is tongued and grooved all around. Run: 100 mm.



Effex sauna panel STS 14 x 112 x 2010

PEAT is brown-stained, high-quality pine panelling that is finger-jointed and knotless. The panel is tongued and grooved all around. Run: 100 mm.

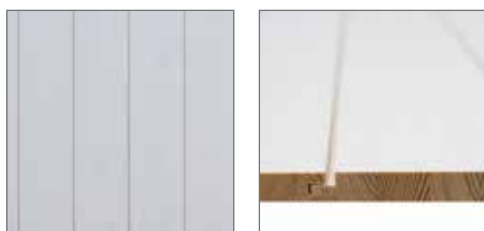

Effex sauna panel STS 14 x 112 x 2010

SNOW is white-stained, high-quality pine panelling that is finger-jointed and knotless. The panel is tongued and grooved all around. Run: 100 mm.



Effex sauna panel STS 14 x 112 x 2010

NATUR is high-quality pine panelling that is finger-jointed and knotless. Well-suited for tinting. The panel is tongued and grooved all around. Run: 100 mm.



Heat-treated brushed alder, STS 15 x 120

The heat-treated brushed alder panelling boards have a brushed surface and a dark colour. The lighting of the sauna brings out the lively surface beautifully. Run: 110 mm.



Smoke sauna panelling board, STP 15 x 95

The smoke sauna panelling boards are made of stained spruce, which brings the warm atmosphere of a traditional Finnish smoke sauna to your sauna. Run: 85 mm.



Solide panel, 24 x 305

The Solide panel is a broad spruce panel, cut from solid CLT spruce boards. The broad panel gives the sauna a calm atmosphere, and its sturdy look exudes the spirit of a log sauna. Run: 290 mm.



Contact the factory to check the availability of wood materials. We reserve the right to make changes.

Bench material

The wood surfaces are the most visible feature of the sauna and bathroom style. The effect of surface materials is integral to the atmosphere. There are several durable, high-quality material options available for Harvia's sauna interior models. Pick your favourite!



Aspen



Heat-treated aspen



Fuma
(only Ventura)



Abachi



Alder



Heat-treated pine



Untreated Spruce
(only Solide)



Transparent white spruce
(only Solide)



Gray Spruce
(only Solide)



Black Spruce
(only Solide)



Details in Sauna

Door handle

Harvia uses a knob door handle and a magnetic latch in its sauna doors. The magnet keeps the door closed, even if throwing water on the heater causes a pressure wave. The magnetic latch is also designed to be completely safe.

Adjustable legs

Harvia saunas are delivered with adjustable legs fitted into the base frame of the sauna. They prevent moisture from the floor from moving into the lower edges of the sauna walls. Adjustable legs also make it easier to assemble the sauna horizontally if the floor is not even.

Benches

The carpentry skills at Harvia are top quality, and this is especially evident in the bench finishing. The Exclusive, Solar, Futura and Ventura interior's benches are detachable and therefore make cleaning an easy task.

Safe floorboard

Harvia saunas are delivered with safe and hygienic plastic floorboards. Special plastic on the underside prevents the floorboards from sliding on the floor surface. The upper surface has a pleasant graining that prevents slipping. The light boards are easy to clean on both sides and are long lasting. As an alternative, you can also order traditional wooden floorboards made from spruce.





Select the heater to match your style

Sauna heaters



The heater completes the sauna atmosphere, which means that it must fit in with the nature of the sauna. In addition to the power and the form of heating, style is an important criterion when selecting a heater. Untreated wood in the benches, for example, suit a stunning pillar-type heater, which highlights the beautiful natural materials in the sauna.

There are many options for heater placement in the sauna. Thanks to control units, an electric sauna heater can now be embedded into the lower bench or placed in a corner, because it can be operated by a control panel, usually placed outside the sauna. Features such as protective sheaths that reduce safety distances and the need for space add flexibility to the placement of woodburning stoves.



Bathe the way you want

Harvia's sauna heater design takes into account the various kinds of heat available. If you like it sharp and hot, choose a heater with a smaller amount of stones, and throw the water onto the stones.

Those who enjoy a gentler heat should choose a pillar-type heater or a Combi heater equipped with a steam generator. The secret to a soft heat lies in the low yet moist temperature.



Stylish and digital controls

Sauna heater control units

Electric sauna heater control units make sauna baths – and especially preparing them – very relaxing. You can find a suitable model in Harvia's versatile selection of control units for traditional heaters, combi heaters as well as infrared cabins.

The selection ranges from a reliable, manual control unit for one heater to more heavy-duty digital control units that allow you to control all electric functions of the sauna – all the way to ventilation and lighting. You can also adjust temperature so that it is perfect for you or a larger group of bathers, exactly when you want it. Thanks to technology, you only need to enjoy the relaxing heat and the sauna experience waiting for you.

Update your sauna with a control unit

An option for the control unit should be considered in the planning stage (cabling). This will allow installation and use of a control unit at a later time.

In the future when the control unit has been installed, you can also replace just the heater and continue controlling it with the familiar control unit. The versatile features and connection to the building automation allow for use in different kinds of situations. Remote control is also possible even with a mobile device, as long as the separate safety equipment in accordance with the regulations, such as door switches and additional safety equipment for the sauna heater, has been taken into account.



XENIO



C170VKK

Heaters for small saunas

Output: 2,3–9 kW • Sauna size: 1,3–14 m³



GLOW CORNER



UNIO



DELTA

Output: 16–16,5 kW • Sauna size: 6–13 m³



M2



LEGEND 150

Heaters for family saunas

Output: 6,8–9 kW • Sauna size: 6–14 m³



CILINDRO PLUS



GLOW



VIRTA



FORTE

Output: 4,5–9 kW • Sauna size: 3–18 m³



THE WALL



THE WALL COMBI



MODERNA

Output: 21 kW • Sauna size: 10–24 m³



LEGEND 240

Heaters for large and public saunas

Output: 7–33 kW • Sauna size: 6–66 m³



CILINDRO PRO



LEGEND



VIRTA PRO



PROFI

Output: 31 kW • Sauna size: 14–36 m³



36 PRO



The new generation of Cilindro Cilindro Plus Spot®

The Harvia Cilindro Plus electric sauna heater is an impressive pillar heater consisting of a massive amount of stones. The heater's outer casing reveals plenty of surface made of these stones. You can control the amount of steam and its heat by either throwing water directly on the stone pillar or on its side. The tall pillar heater is an impressive sight when embedded into the benches, and its brushed stainless steel exterior gives it a finished look. The heaters have been equipped with a new control unit integrated into the heater, which can be controlled using a wireless Spot control switch (delivered with the heater).

Switch on the sauna with the push of a button – wireless Spot control switch

The innovative Harvia Spot wireless control switch makes using the Cilindro Plus Spot sauna heater easy and safe. The wireless Spot switch has no visible cables and it is easy to install. The splash-proof Spot control switch can be installed inside the sauna or the washroom, in the immediate vicinity of the heater.

The stylish, illuminated control switch enables switching the heater on or off with just one light touch. The signal LEDs on the control switch indicate the operating status. The heater's on-time can be adjusted (2h/4h/6h).

The radio signal range is 5–10 metres depending on the wall structures. Spot works on batteries.



CILINDRO PLUS SPOT



Harvia also offers
made-to-measure
glass doors and walls.
Request a quote:
offers@harvia.fi

Harmonise the look of your sauna

Glass walls and doors

All Harvia sauna glass doors have been specifically designed for sauna use. The glass used in the doors is tempered 8 mm safety glass. The sealant keeps the heat in the sauna room and makes sure that the door closes smoothly. Harvia glass door is easy to install. Glass doors are rectangular shaped.

Customized glass walls

The customized glass wall in between the bathroom and the sauna creates an image of a larger space. The customized glass wall is tailored according to your own needs. The door frame material is available in aluminium, aspen and alder. Glass colour is clear or satin. Ask for an offer from the factory.



Glass door

Choose glass colour from smoky grey, warm bronze, modern clear or stylish satin glass. Doorframe material is either pine, aspen or alder. Door size

8 x 21 and 9 x 21 is recommended for use in household and laundry room doors. Satin door is very suitable for internal door, as its matte surface prevents visibility between the rooms.

The delivery includes unfinished 42 x 92 mm door frame, door frame silicone sealant, safety glass, chrome-plated hinges, magnetic lock and chrome-plated lever handle. Alternatively, you can also choose vertical door handle as an option. On request we deliver specially customized doors.

Aluminium frame door

Harvia aluminium frame door is an excellent solution for a steam room or a sauna door. It is designed for conditions where the materials require good humidity resistance. The aluminium frames (40 x 60 mm) are coloured in grey colour. The glass is tempered 8 mm safety glass. Seals keep the heat and steam inside the steam or sauna room. Aluminium frame door is long-lasting and sustainable solution.

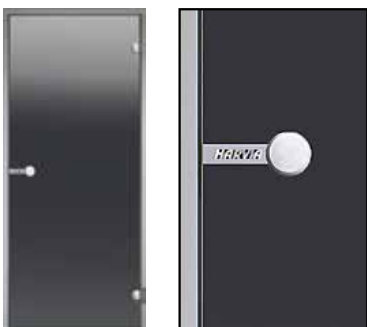

The aluminium frame door is installed with hidden screws leaving no screw-heads visible. The end result is elegant and refined. The door handle is a stylish chrome lever handle. The glass colour options are bronze, smoky grey, clear and satin. The Harvia aluminium frame door is available in both single and double glass door. Satin glass is not available for double door.

Legend glass door

Legend glass door appearance is related to the rustic Legend stoves. The frames are black tinted pine, and the handle is made of black painted hardwood. The glass colour alternatives are: clear, bronze, smoky grey and satin. The Legend glass door is available in all standard sizes 7 x 19, 8 x 19, 9 x 19, 8 x 21 and 9 x 21. The Legend door is also available with black painted aluminium frames.

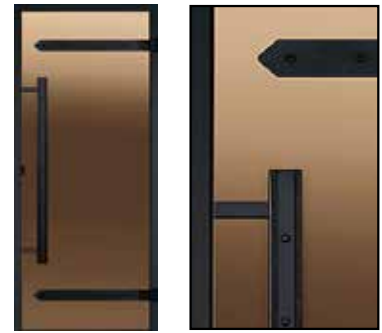

Lockable glass doors

Lockable glass door is suitable for e.g. a dressing room or toilet facilities. The door is available in two sizes: 7 x 21 and 9 x 21. The door frame material is either pine or aluminium. Glass colour is satin. The delivery includes unfinished wooden frame 42 x 92 mm or aluminium frame 40 x 60 mm, silicone sealant attached to the frame, safety glass, chrome-plated hinges and lock case (button and lock are not included in the delivery).



Aluminium strip set

With the aluminium strip set you can finalize the installation of the aluminium frame door. The strip set is available for all standard size glass doors and double glass doors. Black aluminium strip set is designed for the Legend glass doors. The header strip is cut according to the door frame size, the side strips are 2200 mm long and are shortened as needed.













Acid-proof hinges

Acid-proof hinges are the perfect solution for spa environments, such as steam room doors. The hinges are thoroughly tested and conform to the requirements set for public facilities. They do not rust in a spa environment or due to the effects of chloride in swimming pool water. The standard hinges delivered with Harvia doors are also easy to replace with acid-proof hinges.



Select one!

Colour alternatives for glass doors ▶	 Bronze	 Smoky grey	 Clear	 Satin	 <p>Handle options: Knob door handle as a standard, vertical door handle as an option.</p>
	Frame alternatives ▶	 Pine	 Alder	 Aspen	
 Grey aluminium		 White aluminium			



Formula bench, alder

Ensure safe heat

Safety equipment and safety switches

The sauna experience improves considerably when you feel safe. It is much easier to relax when you do not have to be careful when moving about the sauna. The significance of safety is highlighted in families with children in particular, and it is usually among the most important factors when it comes to saunas. Young children can enjoy the heat of the sauna as much as adults do, but they rarely have the patience to keep still for a long time, which may lead to dangerous situations taking you by surprise. Safety is also a very important part of the sauna for elderly sauna bathers.

Avoid accidents by making the right choices

Safety is an essential and important part of the sauna experience. In fact, Harvia offers a comprehensive selection of different kinds of solutions to improve safety. These include:

A **sauna heater safety railing** is a wooden railing installed around a sauna heater for the simple purpose of preventing sauna bathers from touching the heater. The safety railing provides the sauna with an impressive look in addition to safety, which is why we recommend that one be installed in every sauna. Anyone can lose their balance when standing up from the bench after a sauna session.

The **protective sheath** of a sauna heater is attached directly to the side of the heater. The sheath conforms to the shape of the heater and creates a smoother whole. A protective sheath reduces safety distances, allowing the heater to be installed nearer to the sauna's wall or benches in a fire safe manner. Depending on the heater model, one or two protective sheaths can be attached.



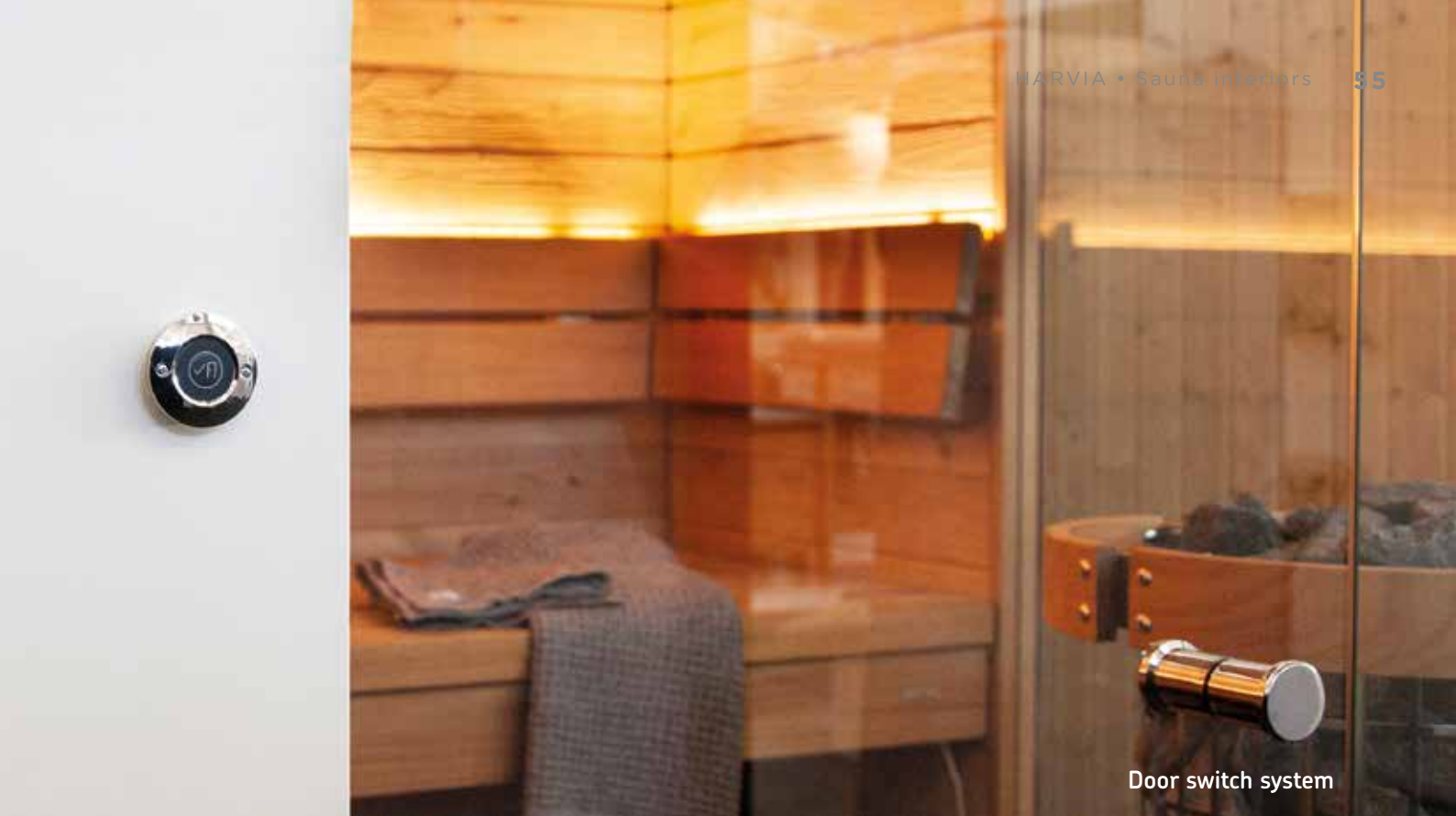

Door switch system

The **door switch system** is easy to connect to the control unit, ensuring the safe remote use of the sauna in accordance with EU standards. The door switches ensure the safety of the sauna before the electric sauna heater is switched on. The switches are installed discreetly onto the sauna door.

The **safety switch** is installed above the sauna heater. The switch always monitors the heater's operation when the heater is turned on. It switches the power off immediately if anything falls on the safety device and stops the sauna heater from switching on.

A **sauna heater control unit** is another good way to affect safety. With the placement of a separate control unit, digital control panel or wireless Spot control switch, you can ensure that children cannot switch the heater on by accident, for example. Harvia's product range also includes child-proof versions of traditional heater models, equipped with fixed operating switches.



Safety equipment completes the design

– create an atmosphere with lighting

Sauna design and safety do not exclude each other. At their best, they support each other. The clear and sleek design of the safety equipment is a perfect fit with current sauna trends.

You can boost the ambience and impressive look of your sauna further by choosing an illuminated safety railing or by equipping the built-in safety railing in your bench solution with a LED light strip.



Add to the atmosphere of your sauna with lighting

Sauna lights



Sauna lights

Choose from two colour options: steel or black. The stylish sauna light is a combination of steel and wood and measures 230 x 180 x 90 mm (width x height x depth). The package includes the lamp and a lampshade. Protection rating IP44, E14 bulb (max. 40 W) not included in the delivery.



LED strip

Indirect lighting based on LED strips is the perfect way to add to the warm atmosphere of your sauna. The LED strips can be easily integrated into sauna benches, for example into the backrest or the front edge of the upper bench. The LED strips are always tailored to suit the benches. The maximum installation height of the LED lights is 1,600 mm. The delivery includes the LED strips, connection cables to the transformer, a terminal strip and a transformer (230 V/12 V). The transformer must be installed in an IP44 rated case and no higher than 500 mm off the floor. A single transformer is enough for 10 m of LED strips.



Illuminated safety railing

Harvia illuminated safety railings increase the lighting, but also the safety of sauna bathers. Safety railing LED light strip illuminates the heater's stones impressively. Made of heat-treated aspen, the railings add a stylish and pleasant touch to the decor of the sauna.



Illuminated embedding flange

An illuminated embedding flange is the perfect pair for the bench-embedded sauna heaters. Made of stainless steel, the embedding flange also protects from the heat radiation, thanks to which the embedding hole is only slightly larger than the heater, making the integration look unified. The LED lights shining up from the bottom accentuate the fractured surfaces of the sauna stones, making throwing water on the stones a sight to behold.



Illuminated bucket – the brilliant container for sauna water

Harvia's illuminated bucket is a modern and practical container for water. It creates ambient lighting in the sauna – exactly where it is needed. You can either embed the illuminated bucket into the bench or mount it on top of the bench to ensure that it always has its own place in the sauna. The LED light in the base illuminates the bucket evenly, and the bucket also casts soft light on its surroundings. The bucket is made of optical plastic for optimal light dispersion. The bucket can easily be lifted off the base for refilling and cleaning. The separate base also ensures that the bucket's electrical components stay protected.



Luminous fibre optic lights – a stylish lighting solution

The Harvia Luminous fibre optic lights provide stylish lighting solutions for both saunas and steam rooms. The flexible fibre optics can be used to add a beautiful starry sky or a variety of graphic patterns to the ceiling or walls of your sauna. Luminous fibre optic lighting is available as different assemblies.





Bench material heat-treated pine.
Autodose sauna water dispenser

Complete your sauna with Harvia accessories

Accessories



Embedding flanges for sauna heaters

With a stylishly slick embedding flange, you can embed your heater in the bench, giving your sauna an impressive and sleek look. The embedding flange is made of stainless steel. You can find more information on heater-specific embedding flanges at www.harvia.fi.



Sauna loudspeakers

Add to the atmosphere in your sauna with Harvia sauna loudspeakers. Connect the loudspeakers to your music player to enjoy your favourite music in the sauna. Harvia sauna loudspeakers are completely waterproof and well-suited for humid rooms, as their IP rating is IP65. Colour options: white or steel. Be sure to plan the wiring before beginning the panelling process. Tip! If you also install loudspeakers in the washroom and dressing room, you will be able to hear the music in every room.



Decorative stone wall

Harvia decorative stone wall helps you to easily create a stylish sauna. It can easily be attached directly onto the sauna panelling. Decorative stone wall is made of quality ceramic stone imitation. The size of the wall element, which is designed for Harvia's ready-made-saunas, is 534 x 1870 mm. The lower part of the decorative stone wall element is made of stylish brushed steel, on which you can mount a heater. Harvia also offers decorative stone wall for higher saunas. The size of this model is 534 x 2040 mm.

Protective illuminated glass sheath for wall-mounted sauna heaters

Harvia's protective glass sheath (HSW5L /HSW5) is a recommended way to increase the safety of sauna bathers around a wall-mounted sauna heater. Made of opti white glass, this beautiful and airy-looking protective sheath completes your sauna interior. The protective glass sheath is tempered, making it safe to use. The protective sheath reflects soft LED light beautifully and completes the ambience of your sauna interior. The protective glass is also available without illumination.

Embedding flange for wall-mounted heaters

Harvia's embedding flange for wall-mounted heaters HSW1 is a perfect match for heaters such as The Wall E and EE when embedded into a sauna bench. This stainless steel embedding flange also provides protection from heat radiation. The installation hole is only slightly larger than the heater, making the integration look unified.

Autodose sauna water dispenser

Forget the bucket and ladle, here comes an automated water dispenser. Just relax and press a button to apply water onto the stones – with or without a fragrance. Spa saunas benefit from the even air humidity and the simplified approach to throwing sauna water.

The device consists of a main unit and operating buttons. The delivery includes one button for water and another button for a water-fragrance mixture. The device works either automatically at defined intervals or at the press of a button. When the device is in automatic mode and water is applied by pushing the button, the timer for the dosing interval restarts.

Design piping for the Autodose automated water dispenser

The stylish and modern Autodose design heater water piping is installed above the sauna heater. An unobtrusive special nozzle will direct the water on a large area, providing a fantastic sauna bath.

The simple design of the piping is well-suited to many different sauna interiors. The piping can also be integrated through the sauna's wall panel, thus hiding the piping and maintaining a clearer sauna interior.

The design piping is suited to heaters of different sizes and its distance can be adjusted based on the size of the heater. The design piping is compatible with the Harvia Autodose automated water dispenser, but it can also be used without (requires separate water control).



A great atmosphere with small things

Sauna accessories and textiles



Legend sauna accessories

The Legend sauna accessory selection includes a ladle, water bucket, thermometer, firewood rack and clothes hanger. The ladle, water bucket and firewood rack have wooden handles made of wood that does not get too hot in the heat of the sauna. The thermometer and clothes hanger are made out of heat-treated aspen and finished with black steel details. You can see the spirit of craftsmanship in all Legend sauna accessories.

Sauna accessories set

The Harvia sauna accessories set includes a stainless steel bucket and ladle and an easy-to-read thermo/hygrometer. The Harvia sauna accessories set goes with your sauna like water goes with the sauna stones – and puts a finishing touch on your stylish interior design scheme. Stainless steel withstands changes in humidity and temperature remarkably well, making it a long-lasting material for heavy-duty use. The handles are made of non-heating wood that is pleasant to take a hold of. The Harvia sauna set is also a great idea for a high-quality gift.

Bucket

The Harvia wooden buckets (4/7 l) and pail are high-quality work. The plastic inner part gives the product a longer life and makes cleaning easy.

Sauna ladle

A wooden sauna ladle can be treated with products suitable for the wood surfaces in the sauna, if desired. Ladle length: 36 / 48 cm. There is a loop at the end of the ladle for hanging the product. Allow the ladle to dry after every sauna bath.

Sauna fragrances

The sauna fragrance by Harvia creates an atmosphere that provides wonderfully indulgent sauna experiences. The Harvia sauna fragrances contain essential oils and create just the kind of atmosphere you want in your sauna. The selection includes the following scents: eucalyptus, citrus, birch, pine, peppermint, apple.

Stool

The stool is made out of alder. You can use products intended for the wood materials in the sauna to treat the stool.

Sauna Care Set

By caring for your wood surfaces regularly you can extend the lifespan of your sauna. The Harvia Sauna Care Set is designed for treating the wood surfaces of the sauna and cleaning the sauna facilities. The set includes one bottle of cleanser for the sauna, paraffin oil, a sponge, protective gloves and sandpaper.

Tip!



Complete your sauna experience with a functional and stylish sauna textile

LUHTA



Harvia by Luhta textiles

Harvia has made sauna experiences possible for already 70 years. In sauna people are naturally relaxed, equal and enjoy the most revitalizing moments of their lives. Together with Luhta Home, Harvia ensures you a perfect sauna experience through sauna textiles of pure simplicity and lasting style. Renewing your sauna and bathroom atmosphere is easy and fast with stylish sauna textiles from Harvia by Luhta.

Harvia by Luhta sauna textiles are made of high-quality waffle linen cotton that feels pleasant on the skin and gives the towels a modern, natural look. The textiles have excellent absorption capacity and dry up quickly after use. The simply stylish and timeless design completes your sauna experience, and it is nice to wrap a large towel around yourself after a relaxing sauna session.

75% cotton, 25% linen, wash at 60°C



TOWEL
SAC80303
80 x 160 cm



WRAP TOWEL
SAC80304
70 x 150 cm



BENCH TOWEL SET
(2 pcs)
SAC80301
45 x 50 cm



SAUNA CUSHION
SAC80300
22 x 40 cm



BENCH TOWEL
SAC80302
45 x 150 cm

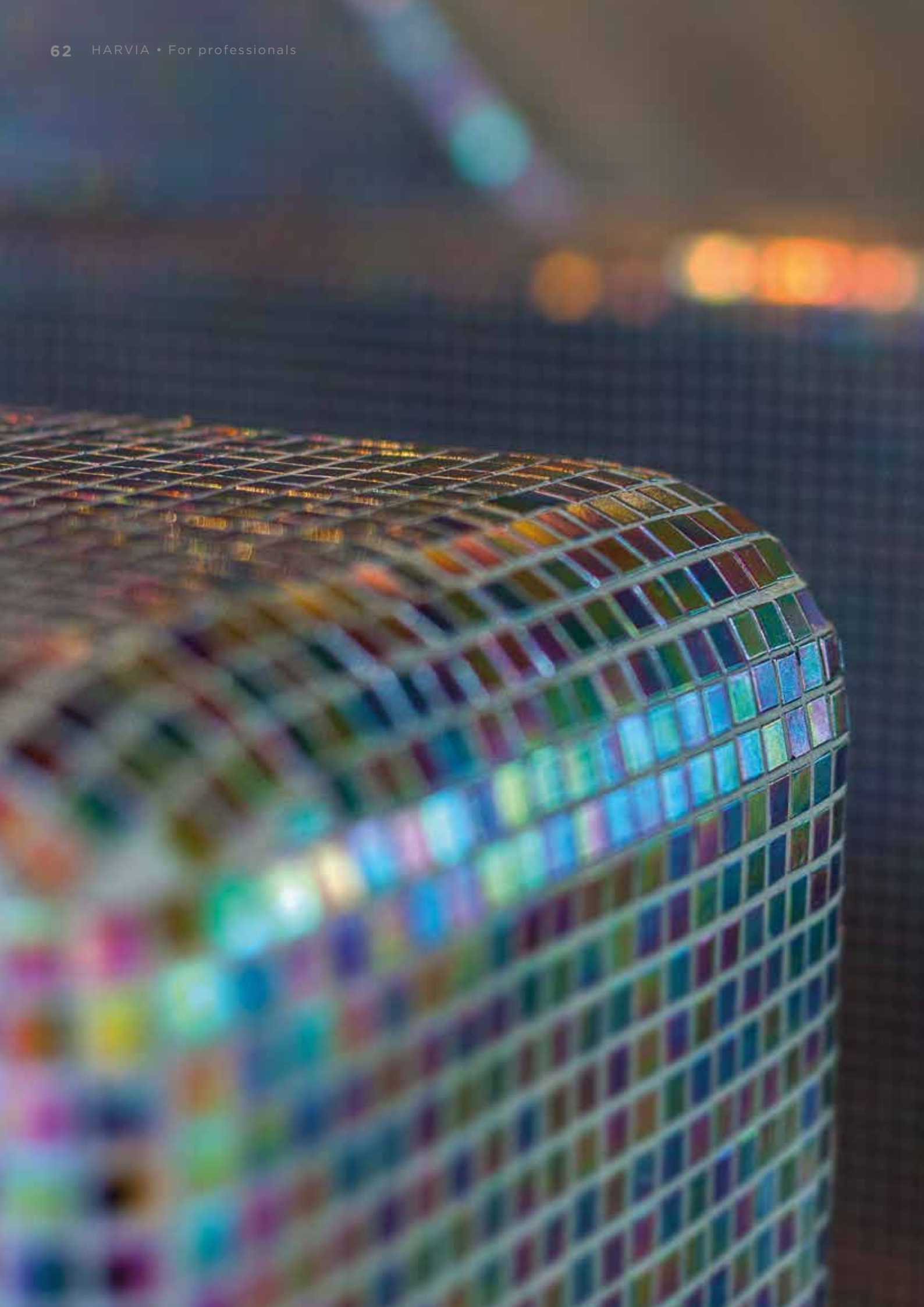



FOR PROFESSIONALS

When dealing with a sauna or spa complex, turn to Harvia. We will help you with all phases of your project, from the first day of design to delivery and after-sales. Our experience in even the most demanding sites, the world's top products and overall service can help you succeed in your work.



Sauna and spa solutions

From Harvia, you can find everything you need for your overall sauna experience, whether it is a traditional sauna or infrared cabin, a steam room, a spa or a hybrid sauna. Our professionals will help you with both design and choosing the products. You can utilise our knowledge and insight of the industry at all stages of the process.

Corporate saunas, spas and hotels

Harvia also provides custom-made sauna interiors for large facilities and sites such as spas and hotels. We design custom benches and panelling based on your wishes, drawings or requests for quote. The design and quality of Harvia's custom-made saunas is backed up by the company's extensive expertise and latest sauna technology. Harvia also offers a strong aluminium frame on which the bench covers with aluminium brackets are placed. The bench covers can be turned up or lifted out for cleaning. It is also easy to replace the bench covers without replacing the frame.

Harvia infrared cabins

With Harvia's infrared cabins, you can offer your spa, hotel and gym guests a pleasant infrared experience easily and reliably. We have delivered infrared cabins internationally for over ten years. Based on our experience, we customise successful infrared solutions according to your needs. An infrared version can be adapted from any of our sauna models and equipped with the decorations, infrared radiators and furnishings suited for the site in question. Our high-quality infrared radiators are easy to install, and they can be easily controlled with a digital touchscreen. Infrared cabins are gaining popularity due to people becoming increasingly interested in their health and well-being. People also often seek health benefits when visiting a spa or using the sauna area of a sports centre or hotel, for example. Long infrared waves have been linked to health and a sense of well-being. The sensation resembles enjoying the warming rays of the sun, but without the harmful UV radiation.



Harvia hybrid saunas

A hybrid sauna combines a traditional sauna with a modern infrared cabin: the same sauna room may have both a heater and infrared radiators as heat sources at the same time. In a hybrid sauna, the purpose of the heater is to provide an enjoyable room temperature and suitable humidity, while the infrared radiator emits heat radiation directly towards the sauna bather. A hybrid sauna is flexible to use; an infrared radiator and heater can be used either simultaneously or separately. An existing sauna is easy to convert into a modern hybrid sauna that doubles the health benefits. Simply add infrared radiators and a control unit for the radiators in your sauna. If you want the same control unit to control the sauna heater as well, select a control unit model which can do just that.

Harvia steam rooms

A steam room differs from a traditional Finnish sauna in that its temperature is lower and the air humidity is much higher. In a steam room, the air humidity rises to a hundred per cent, while the temperature remains at 40–45 degrees Celsius. Instead of a traditional sauna heater, the heat source is a steam generator. The heat and humidity in a steam room relax the muscles and stimulate blood circulation. A relaxing moment in a steam room relieves stress and eases the mind. Harvia provides a package for building a relaxing steam room. We also provide steam room elements, steam generators, control units and lighting.

Harvia Spa Modules

Harvia Spa Modules offer an effective way to implement the furnishings and structures of even the most demanding spa facilities. We provide structural modules for both large spas and your own personal spa oasis. A typical solution includes the walls, ceiling and benches for a steam room, which, thanks to the unique manufacturing process, can be customised to almost any shape imaginable. The delivery comprises the wall, ceiling, seat and other structures as ready-to-install modules. After the modules have been installed, they are levelled, waterproofed and tiled. The installation-ready modules enable effortless implementation of spa facilities – the client only needs to take care of the waterproofing and tiling.

*One partner –
that is all you
need
Contact us:
offers@harvia.fi*



Lapland Hotels Bulevardi, Helsinki

A hundred different sauna experiences



The Lapland Hotels Bulevardi is the third city hotel of the Lapland Hotels chain, for which an extensive sauna project was carried out together with Harvia. The chain's style combines the straightforward ambience of Lapland with modern interior design.

The hotel rooms of Lapland Hotels Bulevardi are larger than usual – most of them are high-quality suites or deluxe rooms. Harvia's experts created customised sauna solutions for the room, with the end result being a uniform interior design style.

The challenging project included building more than a hundred separate saunas. The expertise of Harvia's sauna designers and the 3D models were used to make working at the construction site much easier.

'We want to provide tourists with something new and experiential. The end result is excellent. We received impressive solutions and strong structures – I have nothing to complain about in regards to our cooperation,' says Project Manager Bjarne Nikkilä from Lapland Hotels.

All saunas in the hotel have benches by Harvia and Cilindro heaters with a digital control unit. In addition, special solutions that complete the personal style were also implemented in the saunas. The bathrooms play a significant role in the deluxe rooms in particular, as they are almost half of the hotel room in size. The space is divided by a beautiful glass wall, so the hotel room is visible from the benches in the sauna and vice versa.

Hotel Manager Tuomas Tihinen from Lapland Hotels Bulevardi is satisfied with the end result. 'Customers like the fact that we are bold enough to be a little different. Many have commented that this was the best hotel sauna that they have ever been to.'



Seth Ascetic, Taiwan

Beautiful sauna area for a luxury sports centre

The Taiwanese Seth Ascetic is a private luxury sports centre. Its well-being services offer experiences that balance body, mind and soul. Now, the set of unique services also includes a genuine Finnish sauna.

The sauna area was built next to the sports centre so that you can package a relaxing sauna experience as a part of the visit. The sauna project comprised the implementation of two Harvia saunas and two steam rooms, one of each for men and women. Seth Ascetic wanted a tiered sauna with the benches mounted at different heights.

Harvia's sauna designers tailored the solutions according to the wishes. The tiers were achieved by combining both fixed bench structures and separate sauna benches. The LED light strip on the bottom edge highlights the structure and differences in levels. The heater guard was integrated into the benches seamlessly. Heat-treated aspen was chosen as the material for the panelling and benches of the sauna rooms.

'In Taiwan, we appreciate products made of natural high-quality materials, and we are interested in Nordic nature. Seth Ascetic seeks to be a forerunner in the field of comprehensive well-being, which is why we wanted to include a Finnish sauna as part of our services,' says Project Manager Karl Chi from Seth Ascetic.

The project also included the implementation of two identical customised steam rooms in the sauna area. The steam rooms were fitted with curved seats that encircle the rooms, and a number of ambient fibre optic lights were installed on the ceiling and under the seats.

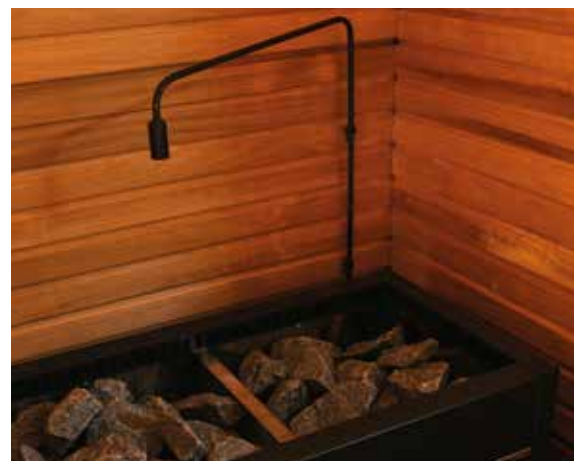



Floor plans

Claro

S2116LS

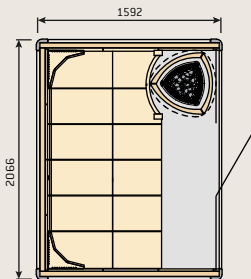

S2121LS

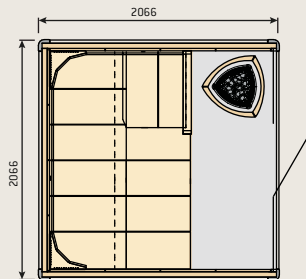

Solide

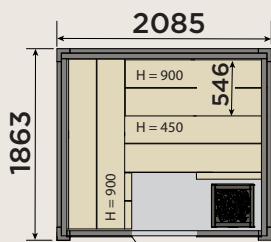

S2119LD

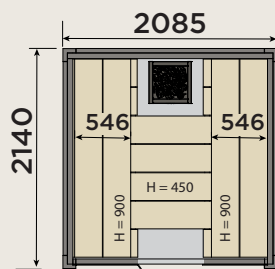

S2122LD

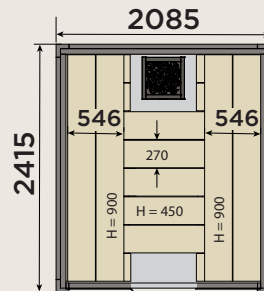

S2125LD

Rondium

Rondium S2015

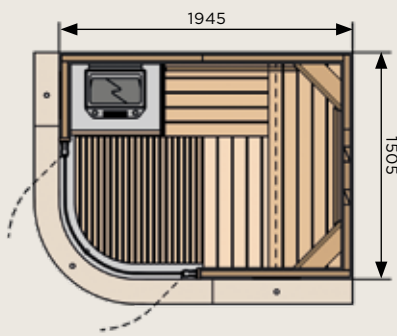

Rondium S2015

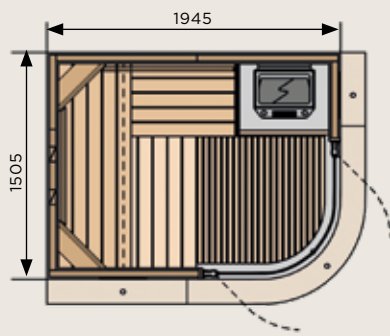

Rondium S2015 infra

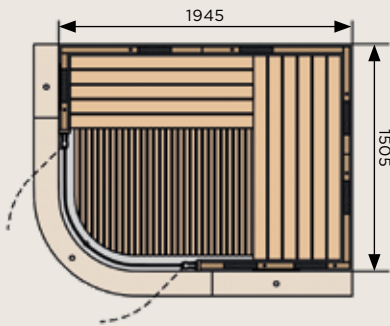

Rondium S2015 infra

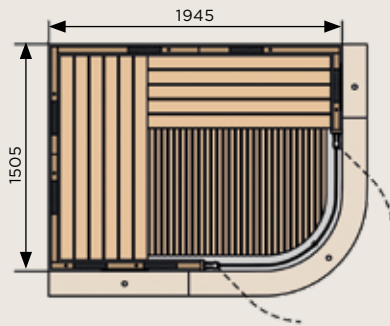

Rondium S2020

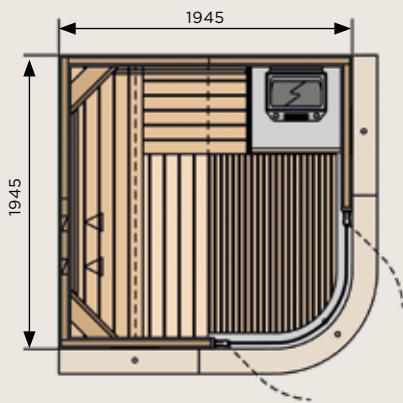

Rondium S2020 infra

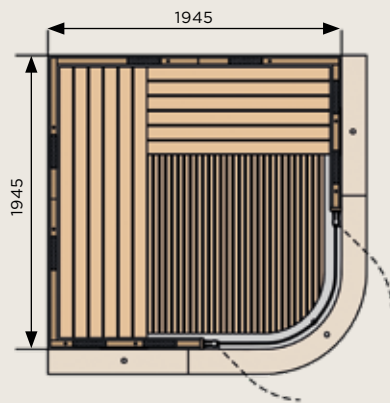

Rondium S2222

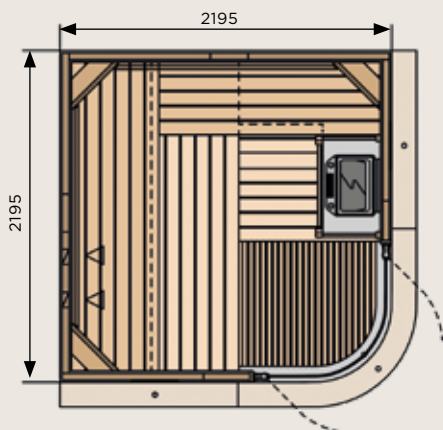

Rondium S2222 infra

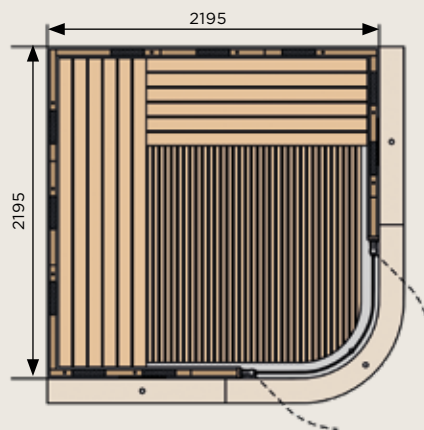

Variant

S1212

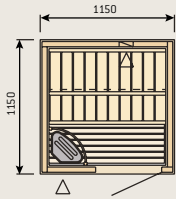

S1515

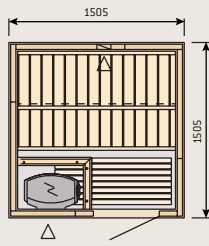

S1515R

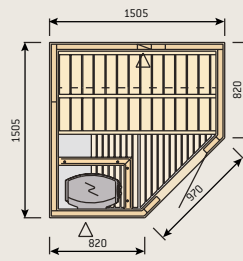

S1515L

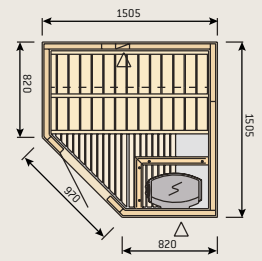

S2015

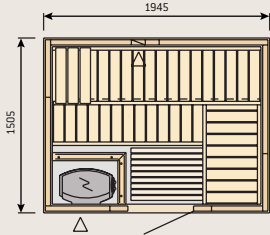

S2015R

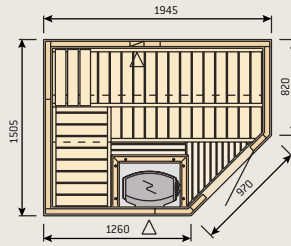

S2015L

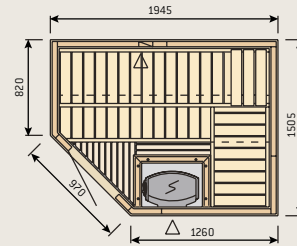

S2020

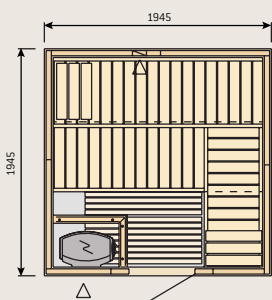

S2020R

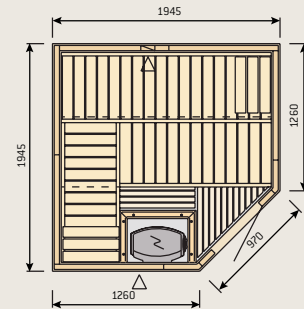

S2520

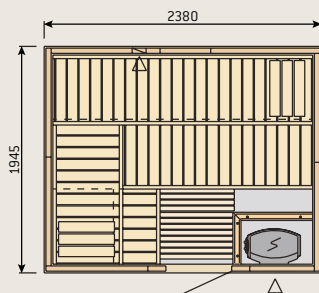

S2520R

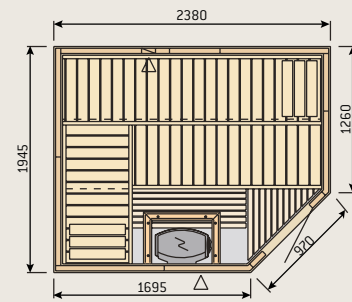

S2520L

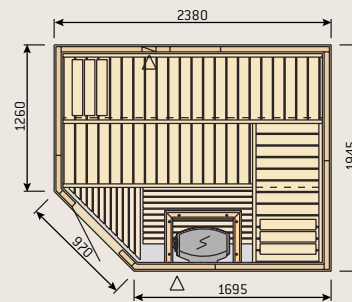

S2020

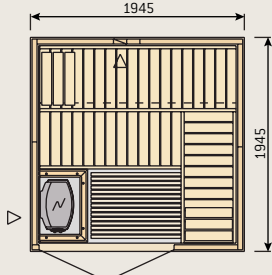

Double doors are available for the models S2020 and S2520.

Variant View

S1212SV

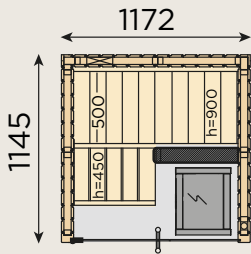

S1616SV

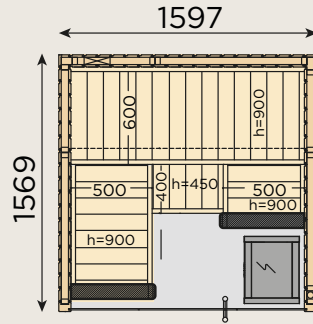

S1620SV

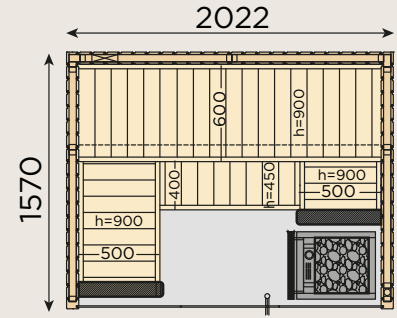

S2020SV

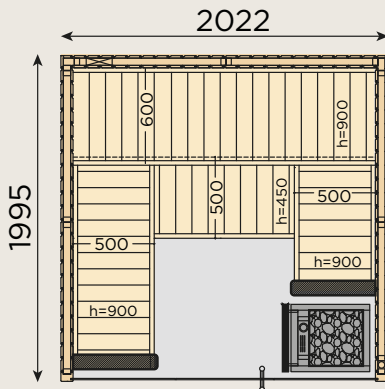

S1616CV

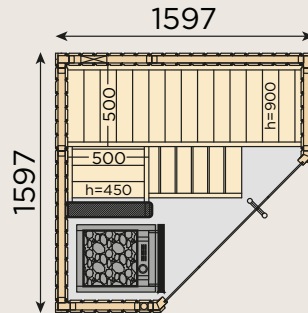

S2020CV

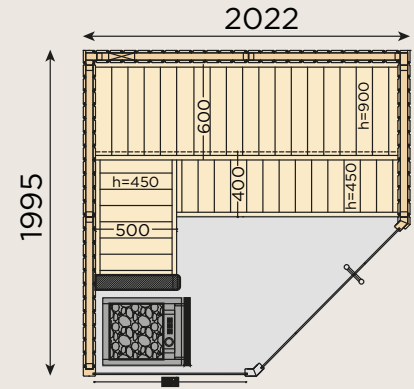

HARVIA

Sauna & Spa

P.O. Box 12
FI-40951 Muurame, FINLAND
Tel. +358 207 464 000
harvia@harvia.fi
www.harvia.com



@ harviaglobal