



### 1 DESCRIPTION

The DA-GEN is an innovative water treatment system and additional an intelligent pool controller. The DA-GEN combines Hydrolysis with Electrolysis with a low mineral content.

The Hydrolysis produces free radicals and other oxygen compounds like ozon, peroxide and persulfate. All these oxidants destroy organic substances and pathogena in the water. Free radicals are the strongest oxidants we know. They oxidise and decompose in a few seconds. To guarantee a safe depot disinfection the DA-GEN produces a very small amount of chlorine. In combination with DAISY we need a very low mineral content of 1 to 2 kg MgCl<sub>2</sub> or 0.75 to 1.5 kg NaCl per m<sup>3</sup>.

The DA-GEN controls also all your pool components centrally. Thanks to WIFI you can check and control your pool system 24/7.



#### Electronic box



- 1** Connection cell 110-230 V
- 2** Flow detector
- 3** Main connection 230 V
- 4** ON/OFF switch



- 5** Fuse for device and cell 4 A
- 6** Fuse relays 4 A

#### Cell

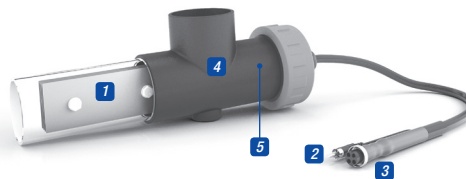

- 1** Cell
- 2** Flow detector
- 3** Cell connector
- 4** Cell housing
- 5** Flow/gas detector (internal)

### 2 SYSTEM INSTALLATION

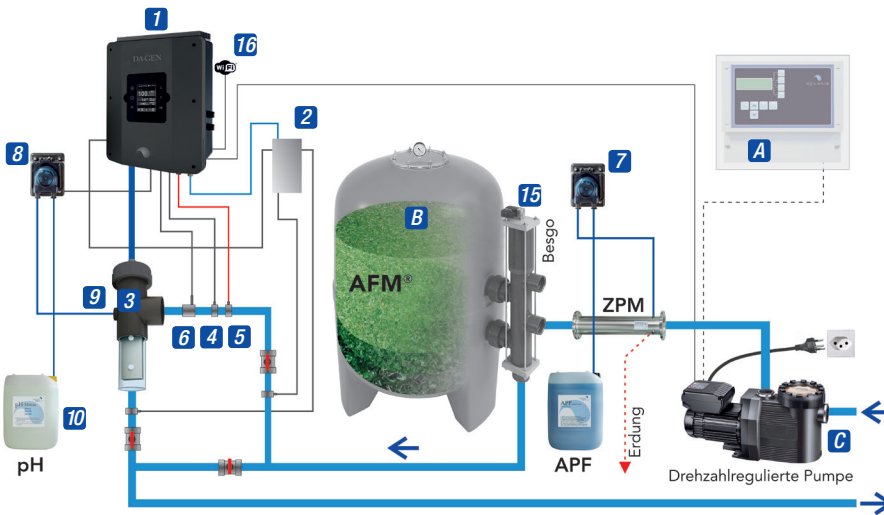

- A** External pump controller\*
- B** Filter with AFM®
- C** Filter pump
- 1** Electronic box
- 2** Measuring cell free chlorine
- 3** Cell (always in vertical position if installed without flow switch)
- 4** pH probe
- 5** Redox probe or conductivity probe (Optional)
- 6** Flow switch
- 7** APF dosing pump
- 8** pH dosing pump
- 9** pH injection
- 10** pH-Minus container (not included)
- 15** Besgo valve (not included)
- 16** WIFI module

#### Electrical consumption

It's recommended to use a time delay circuit breaker of 13 A for private devices and a time delay circuit breaker of 16 A for public devices. In case of sharing the power supply with other devices please consult a technician in order to dimension a correct installation.

| Product    | Maximum consumption | Product    | Maximum consumption |
|------------|---------------------|------------|---------------------|
| DA-GEN 24  | 125W                | DA-GEN 240 | 1000 W              |
| DA-GEN 45  | 180W                | DA-GEN 360 | 1020 W              |
| DA-GEN 90  | 175W                | DA-GEN 500 | 2880 W              |
| DA-GEN 150 | 680 W               |            |                     |

Private

Public

#### \* Filtration control by external timer

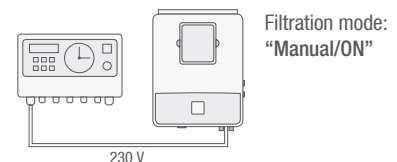

#### \* Filtration control by internal timer

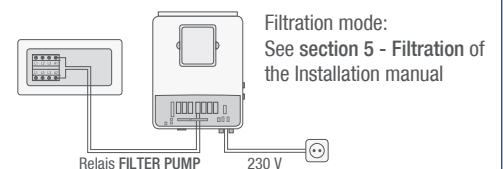

### 3

## INITIAL WATER ADJUSTMENTS

### Water adjustments

- 1 Adjust the alkalinity between 100 and 200 ppm.
- 2 Adjust the pH between 7,0 and 7,4.
- 3 Adjust the chlorine between 0,1 and 0,5 ppm.

### Adding activator/salt to the water

- 1 We recommend to add 1 to 2 kg magnesium chloride or 0.75 - 1.5 kg normal salt per m<sup>3</sup> of water. Der TDS should be at around 1200.
- 2 Add the magnesium chloride or salt directly to your swimming pool water or in the compensation tank and let the system run.
  - The system will operate without problems with salt concentrations from 1 g/l to 50 g/l.
  - In outdoor pools it is necessary to use ACO.

### 4

## MAINTENANCE

### Cleaning the titanium cell

If necessary, carry out a monthly visual inspection. To clean the cell:

- 1 Remove the cell from its support (after turning off the filtration system and closing off the necessary valves).
- 2 Place the cell for no more than 10 minutes in 3% hydrochloric acid (1l of acid for each 10l of water).
- 3 Once the incrustations have softened remove with a hose to complete cleaning the cell.

**DO NOT USE METALIC OR SHARP OBJECTS TO REMOVE INCRUSTATIONS. Scratching the edges or surface of the cell will make it vulnerable to chemicals, deteriorate the cell and cancel the guarantee.**

### Monthly checks

**SALT CONCENTRATION:** ~1200 ppm TDS

**TITANIUM CELL:** Visual inspection to detect incrustations.

### General maintenance

- 1 The pool must be vacuumed as usual and the skimmers emptied whenever necessary.
- 2 **FILTER BACKWASHING:** Once every week for 4 to 5 minutes should be sufficient (providing the filter pressure does not exceed 1 bar, in which case a filter cleaning may be necessary).  
**VERY IMPORTANT:** Make sure the cell is off while cleaning the filter. If the system controls the filtration pump, use the option "filter cleaning" of the programmed filtration mode. See section 5– Filtration / Filter Cleaning of the General Installation Guide.
- 3 **DOSING PUMPS:** Check regularly to ensure that the containers contains liquid to prevent the dosing pump of running dry.
- 4 **pH / Redox / CONDUCTIVITY – PROBES:** The probes must be cleaned and recalibrated every 2 to 3 months.  
To clean the probe insert in distilled water (clear liquid). After each cleaning the probes must be calibrated. Also: the probes should never dry out and must be kept wet if stored (when emptying the pool for winterizing, make sure to store the measuring head in water).

## 5 TROUBLESHOOTING

### Blank display

- Check if ON/OFF switch is illuminated.
- Check the connection wire between display and motherboard.
- Check fuse of the device 3.15 A – it could have tripped due to overload.
- Check the power supply – 230V/50Hz.
- If problem persists contact TECHNICAL SERVICE

### Excess of chlorine in the water

- Lower electrolysis cell intensity.
- If your system includes automatic Redox control, check Redox setpoint value. Reduce it by 50 to 100 mV.
- If your system includes free chlorine measurement, adjust the setpoint value.
- Check redox probe and calibrate it if necessary.

### Electrolysis does not reach the setpoint value

- Low water temperature.
- Check salt concentration (TDS) in water.
- Check cell status (may be incrustated or calcified).
- Clean the cell according to the instructions in section 4.
- Clean the flow detector situated in the cell housing.
- Check titanium cell is not worn out (remember that the cell is guaranteed for 5.000 hours, approx. 2-3 years of summer usage).

### Titanium cell incrustated in less than 1 month

- Very hard waters with a high pH and total alkalinity: balance water adjusting pH and total alkalinity.
- Check to ensure the system automatically changes polarity every 300 minutes approximately.
- Consult with our technical service to consider accelerating the polarity change (auto-cleaning). WARNING: Accelerating the polarity change decreases the cell life (5.000 hours) proportionally.
- Reduce pH set point to 7.0

### Free chlorine level don't reach the setpoint value

- Increase filtration hours to 24 hours
- Increase electrolysis level.
- Check the salt concentration (TDS) in the water. Setpoint value app. 1200 ppm.
- In an outdoor pool: Add ACO to the water.
- Check if reactive agents in test kit are expired.
- Check if the temperature or amount of users has risen.

### Alarm AL3 and pH dosing pump stopped

- The maximum dosing time (standard 200 min.) is accomplished and the acid dosing pump stops in order to avoid the acidification of the water.
- To delete the message and to restart the metering press ESC (⊙). Do the following verifications in order to preclude errors on the device: Verify if the pH probe reading is correct (if not, calibrate the probe or substitute it with a new one); Verify if the acid/base deposit is full and if the dosing pump is working correctly; Verify the variable speed of the dosing pump.

### Electrolysis display shows FLOW

- Check flow detector cable.
- Clean incrustations of flow detector at the top of cell housing.
- Check if system is free of air (probe must be always submerged).

### Rust on metallic components in the pool

- Metallic elements lack standardized earth connection. Contact an electrician to solve the problem.
- Rusted components are not stainless steel (minimum 316/V4A/1.4571).
- The salt concentration (TDS) is too high.

### Polarity 1 reaches maximum intensity, but polarity 2 (auto clean) does not reach maximum intensity

- If salt concentration is correct (1 - 2 kg/m<sup>3</sup> MgCl<sub>2</sub> or 0.75 - 1.5 kg/m<sup>3</sup> NaCl): Cell is reaching its end of life. As of this moment check intensity every 15-20 days.
- When polarity 2 does not reach medium intensity, we recommend substituting the cell for a new one if it happens during the summer period. If it happens during winter, change the cell before the next summer period.

#### WARNING

Keep chemical levels in pool as instructed in this manual.

#### CLEANING FILTER

Very Important: Make sure the cell is off while cleaning the filter. If the system controls the filtration pump, use the option "filter cleaning" of the programmed filtration mode. See section 5 – Filtration / Filter Cleaning of the General Installation Guide.

#### VERY IMPORTANT

Remember that the system needs some time to adapt to your pool and that you will have to increase chemical levels for the first 5 days.

#### EARTHING

All metallic components in the pool such as lamps, ladders, heat exchangers, drains or similar elements within 3 m from the pool (10 feet) must be connected to an earth below 37 Ohms. If using heat exchangers, we recommend them to be made of titanium.

#### SECURITY

To avoid accidents, children should not handle this product unless supervised by an adult. Children should be supervised at all times when in or near a spa, pool or jacuzzi.

#### HANDLING AND DOSING DANGEROUS CHEMICALS

Chemicals should be handled with extreme precaution. When preparing acid, always add acid to water, never add water to acid, because very dangerous gasses may be produced.





### 1. ELECTRONIC BOX ELECTRICAL CONNECTIONS

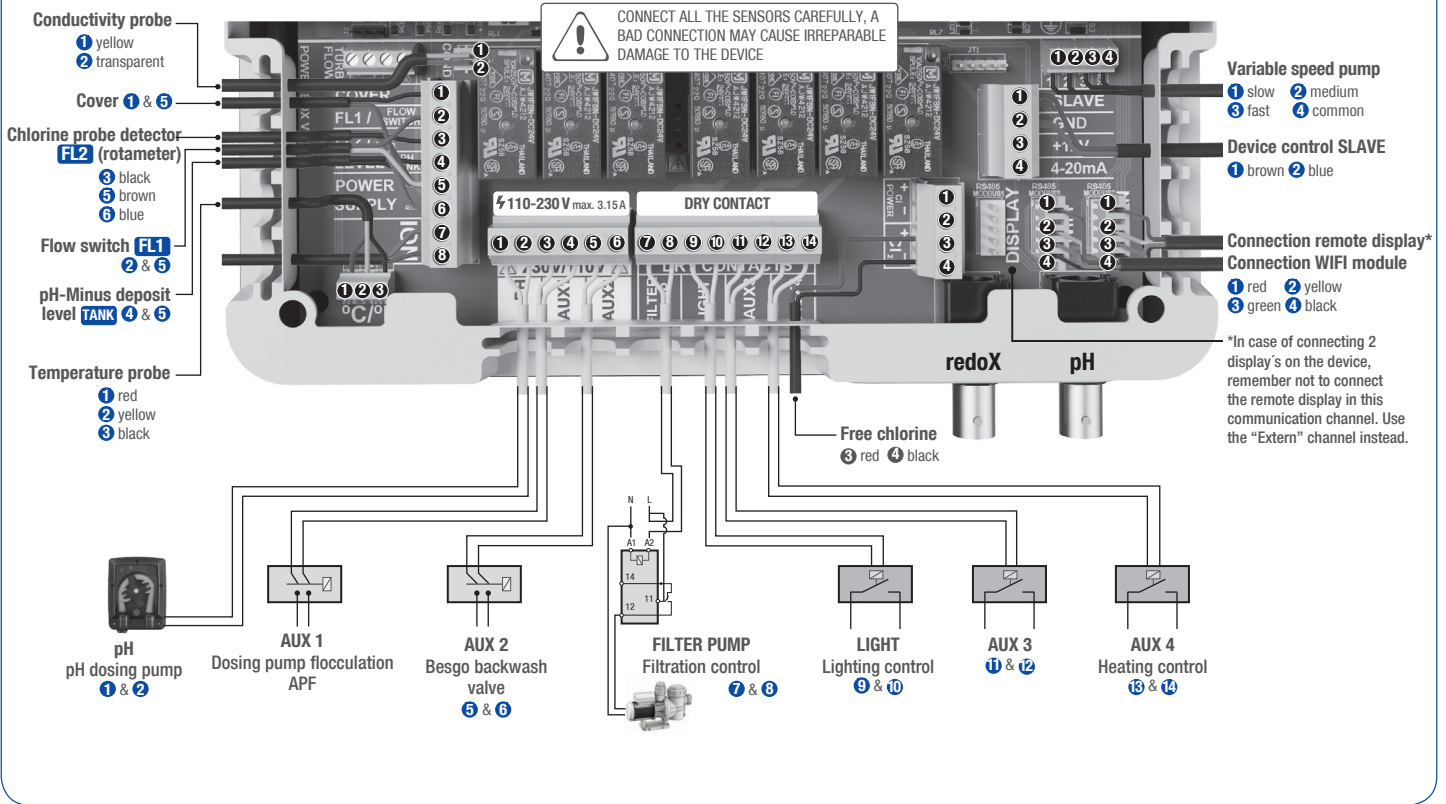

### 2. MAIN SCREEN

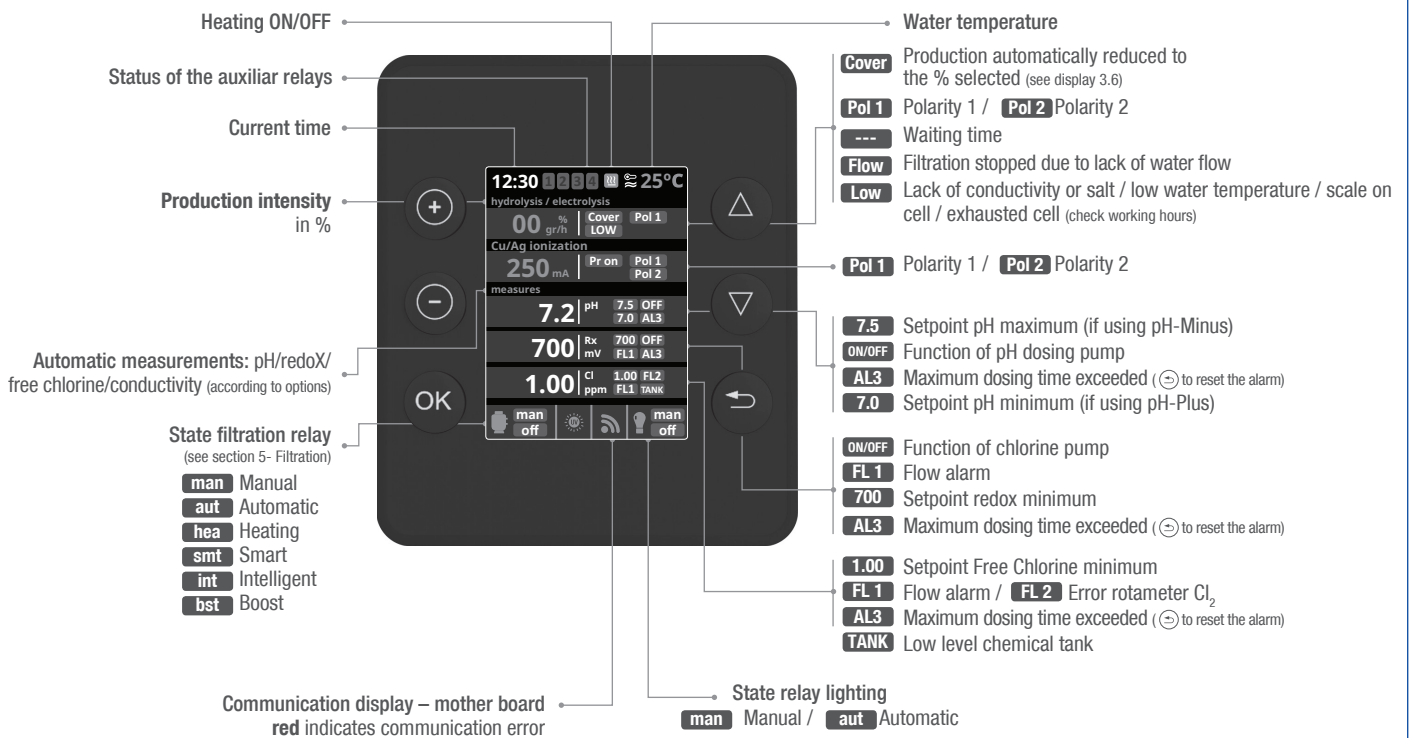

### 3. HYDROLYSE / ELEKTROLYSE

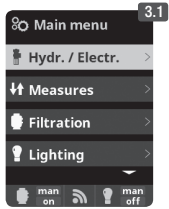

**3.1 Hydrolysis/Electrolysis:** Programming of hydrolysis or electrolysis functions (according to model).

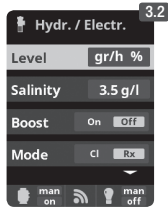

**3.2 Level:** Hydrolysis - Desired disinfection production (%).

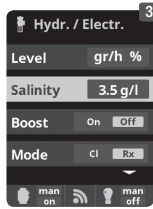

**3.3 Salinity:** Measuring gr/l of salt in water. See section 9-Salinity.



**3.4 Boost:** Filtration during 24h at max intensity. Automatic return to programmed filtration mode. During the boost period the redox control can be deactivated.

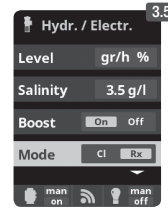

**3.5 Mode:** If the device has Free Chlorine and redox probes, choose the parameter that controls the cell's chlorine generation.



**3.6 Cover:** connection of automatic cover. See section 10-Cover.

### 4. MEASURES / SETPOINTS

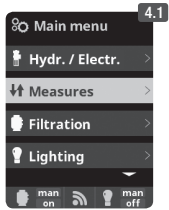

**4.1 Measures:** Adjustment of setpoints and measuring probes.

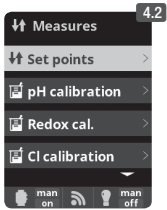

**4.2 Setpoints** for each measurement.

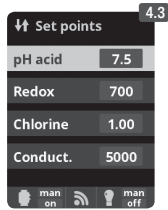

**4.3 Setpoints settings:** Ideal setpoints for each of the parameters. The default values are:

**pH:** 7.0-7.4; **redox:** 600 - 800 mV; **free chlorine:** 0.1- 0.5 ppm; **conductivity:** ~ 2000

#### 4.1 MEASURES / pH Calibration

##### Optional pH control

Metering and control of the pH of the water

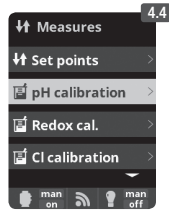
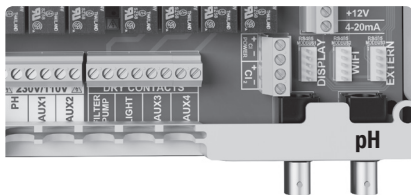

**4.4 Calibration of pH probe:** Recommended every month during usage season.

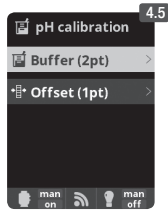

**4.5 Calibration with buffers** (buffer solutions pH7 / pH10 / neutral): Follow the instructions in 7 steps that appear in the display (screen 4.6 corresponds to step 1).

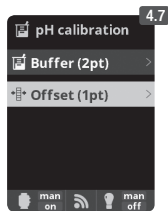
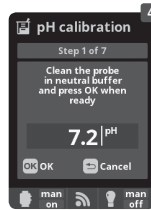

**4.7 Manual calibration:** Allows to adjust the probes at 1 point (without buffers) – only recommended to adjust small deviation in the readings.



**4.8** Without removing the probe from the water, use the **plus/minus** keys to adjust the reading so it matches with your reference value (photometer or other measurement).

#### 4.2 MEASURES / redox Calibration

The redox value advises us of the oxidation/reduction potential and is used to determine the level of water sterilization. The parameters or setpoints are the minimum/maximum accepted redox levels before the titanium cell is connected/disconnected. Adjusting the ideal redox level (setpoint) is the last step in the system start up sequence. Remember to check the redox set-point every 2-3 month and/or if the water parameters change (pH/temperature/conductivity).

##### Optional redox control

Metering and control of the redox as check value of the free chlorine.

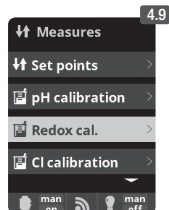
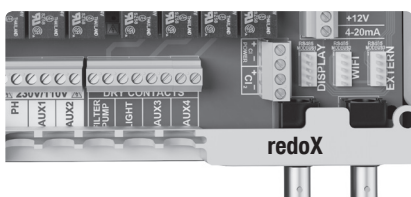

**4.9 Calibration of the redox probe:** Recommended every 2 months during usage season.

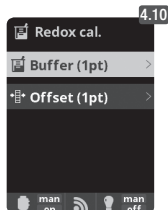

**4.10 Calibration with buffer** (buffer solution 465 mV): Follow the instructions in 4 steps that appear in the display (screen 4.11 corresponds to step 1).

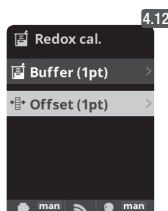

**4.12 Manual calibration:** Allows to adjust the probes at 1 point (without buffers) – only recommended to adjust small deviation in the readings.

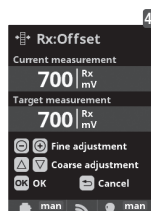

**4.13** Without removing the probe from the water, use the **plus/minus** keys to adjust the reading so it matches with your reference value (photometer or other measurement).



### 4.3 MEASURES / Free Chlorine calibration

#### Optional Free Chlorine control

Metering and control in ppm of the free chlorine of the water.

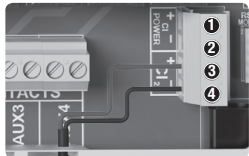

Free Chlorine probe  
③ red ④ black

Chlorine probe detector  
FL2 (rotameter)  
③ black  
⑤ brown  
⑥ blue

In case of using a Variable Speed Pump, calibrate the probe using the most common filtration speed.

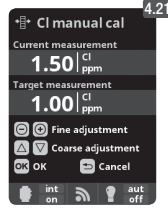
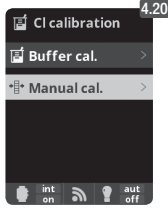
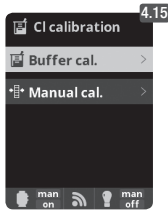
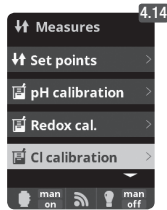

**4.14** Calibration of the Free Chlorine probe: Recommended every month during usage season.

**4.15** Calibration with buffer (photometer DPD1): Follow the instructions in 6 steps that appear in the display.

**4.16 Step 1 of 6** - Calibrate Cl at 0 ppm (offset): Close the valve at the probe input and wait until the reading is less than 0,10 ppm. Wait between 5 to 60 min. Press **OK** when the reading is close to 0.

**4.17 Step 3 of 6** - Calibrate Cl: Open the water flow until achieving 80-100 liters/hour. Wait until obtaining a stable reading of ppm. Wait between 5 to 20 min. Press **OK** when the reading is stable.

**4.18 Step 5 of 6** - Establish the real ppm values with the **plus/minus** keys according to your analysis result of DPD1 (free chlorine).

**4.19 Step 6 of 6** - If this screen is not shown repeat the calibration process.

**4.21** Manual calibration: Open de water flow and set the flowmeter (rotameter) at the right level of flow (80-100l/h). Wait some minutes until the current level is stable. With the **plus/minus** keys, insert manually the water chlorine level (use a manual DPD1 test kit). Press **OK** when the DPD1 value is correct on display (target measurement).

### 4.4 MEASURES / Conductivity calibration

#### Optional Conductivity probe

Metering and control of the conductivity of the water in Msiemens.



Conductivity probe  
① yellow  
② transparent

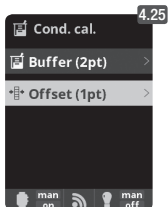
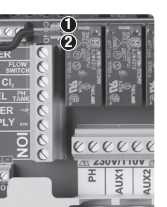
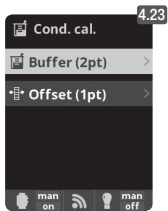
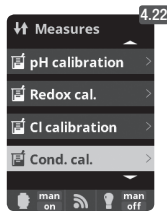
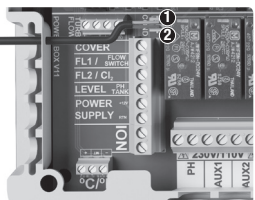

**4.22** Calibration of the Conductivity probe: Recommended every month during usage season.

**4.23** Calibration with buffer (buffer solution 1413 µS/ 12880 µS/ neutro): Follow the instructions in 7 steps that appear in the display (screen 4.24 corresponds to step 1).

**4.25** Manual calibration: Allows to adjust the probes at 1 point (without buffers) – only recommended to adjust small deviation in the readings.

**4.26** Without removing the probe from the water, use the **plus/minus** keys to adjust the reading so it matches with your reference value (photometer or other measurement).

### 4.4 MEASURES / Temperature calibration

#### Optional Temperature

Temperature probe necessary to activate the filtration modes: heating, intelligent, smart.



Temperature probe  
① red  
② yellow  
③ black

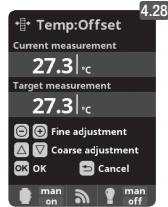
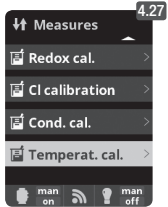
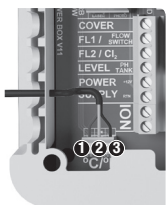

**4.28** Temperature calibration: To set difference between the measured value of the probe and the actual temperature, use the **plus/minus** and **up/down** keys. Set to the actual temperature of the probe and press **OK**.

### 5. FILTRATION / Manual mode

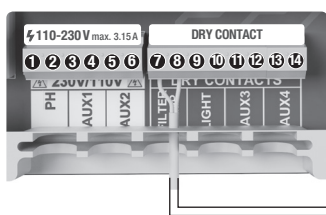

Setup and connection of a Variable Speed Pump, see section 13 - Variable Speed Pump

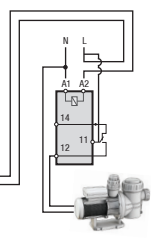

FILTER PUMP  
Filtration control ⑦ & ⑧

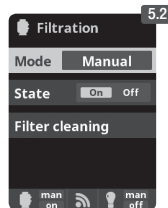
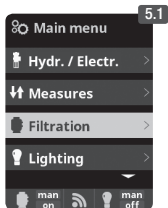

**5.1** Filtration: Configuration control of the filter pump. To set, select Filtration and confirm by pressing **OK**. The mode selection is done in Mode line with the **plus/minus** keys.

**5.2** Manual: Manually turns **ON/OFF** the filtration process. No timing or additional functions. The State line indicates whether the filtration pump is **ON**. See section Filter Cleaning below.

## 5.1 FILTRATION / Automatic modus

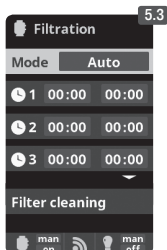

### 5.3 Automátic (or with timer):

In this mode the filtration is switched in accordance with a timer that allow to adjust the start and end of the filtration. Timers always operate daily, in cycles of 24 hours.

To set the **ON/OFF** times (up to 3 possible time programmable), select with the **up/down** keys in the timer line you want to change (1-3).

The **plus/minus** keys opens the selected start time field. Set the time with **plus/minus** keys. Scroll with the **up** key to the minute field and set it up with **plus/minus** keys. To confirm press **OK** and to cancel press **return/scape**. To set the **OFF** timer, proceed accordingly.

See section Filter Cleaning below.

## 5.2 FILTRATION / Smart modus



**5.4 Smart\***: This mode uses, as a basis, the automatic or timer mode, with its 3 intervals of filtration, but adjusting the filtration time in function of the water temperature. For that reason 2 parameters of temperature are provided: The maximum temperature, from which on the filtration times will be the ones from the timer setting. The minimum temperature: below this value the filtration time will be reduced to 5 minutes, which is the minimum working time. Between these 2 temperatures the filtration times will climb linearly.

Use the **plus/minus** keys to set the desired minimum and maximum temperatures.

There is an option to activate the antifreeze mode in which the filtration will start if the water temperature is below 2° C.

To set the **ON/OFF** times (up to 3 possible time programmable), follow the instructions of the Automatic Mode.

See section Filter Cleaning below.

\* **Note:** Mode only visible if the option to use temperature probe and/or heating is activated in the "Installer Menu".

## 5.3 FILTRATION / Heating mode

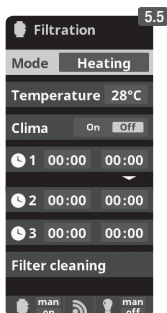

**5.5 Timed heating with option of climatization\***: This mode acts equally to the automatic mode, but besides it includes the option to work on a relay to control the temperature. The desired temperature is set in this menu, and the system works with a hysteresis of 1 degree (example: the setting temperature is 23° C, the system will activate itself when the temperature goes below 22° C and will not stop before it passes 23° C).

Use the **plus/minus** keys to set the desired temperatures and **ON/OFF** of the Heating.

**Clima OFF**: The heating only works within the set filtration periods.

**Clima ON**: Keeps the filtration working when the filtration period is finished if the water temperature is below the setting temperature. When the setting temperature is reached the filtration and the heating will stop and will not switch on till the next programmed filtration period.

To set the **ON/OFF** times (up to 3 possible time programmable), follow the instructions of the Automatic Mode.

See section Filter Cleaning below.

\* **Note:** Mode only visible if the option to use temperature probe and/or heating is activated in the "Installer Menu".

## 5.4 FILTRATION / Intelligent modus

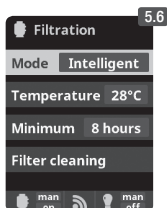

**5.6 Intelligent\***: In this mode the user has 2 working parameters to guaranty the desired water temperature with a minimum of filtration hours:

You select the desired water temperature and the minimum filtration time (minimum of 2 hours and maximum of 24 hours). The device divides the selected "minimum filtration time" in 12 fragments which start up every 2 hours. If one of these fragments finishes, without the temperature reaching the desired level, the filtration/heating continues until the desired temperature is accomplished. In order to keep the filtration-electricity-cost to a minimum, this additional filtration time is subtracted from the following fragments of the "minimum filtration time". The first 10 minutes of each fragment will not be subtracted.

Example (see diagram): Minimum temperature = 28°C and minimum filtration time = 12 hours.

The desired water temperature and the minimum filtration time is set with the **plus/minus** keys .

See section Filter Cleaning below.

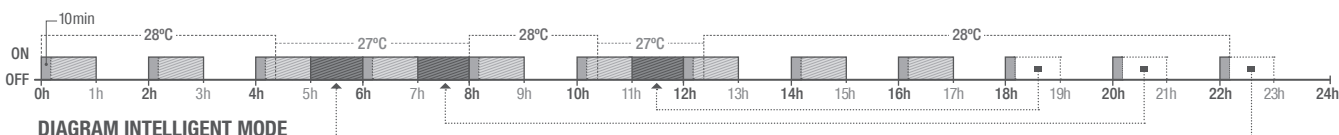

\* **Note:** Mode only visible if the option to use temperature probe and/or heating is activated in the "Installer Menu".

## 5.5 FILTRATION / Automatic backwash

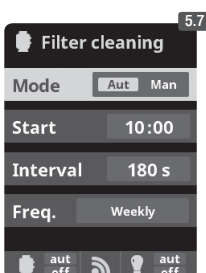

**5.7 Mode Backwash with Besgo Valve**: If the system is equipped with an automatic backwash valve from Besgo, do the following settings. A shut down of the pump is not necessary with a Besgo valve. Use AUX 2!

- Mode: Choose Auto
- Start: Choose starting time
- Interval: Set backwash time in seconds (Recommendation: min. 240 seconds with AFM®, min. 300 seconds with Sand)
- Freq.: Choose frequency (Recommendation: weekly)

## 6. LIGHTNING

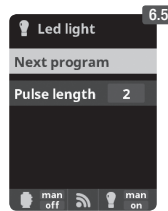
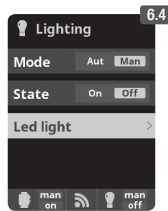
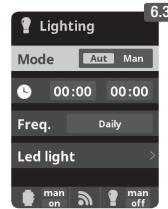
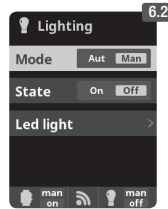
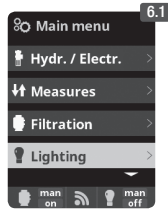
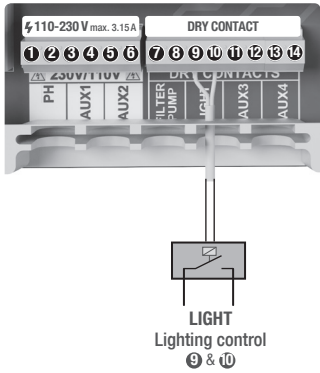

### 6.1 Lighting

### 6.2 Manual Mode (ON/OFF).

**6.3 Automatic Mode:** Shuts lights **ON/OFF** according to a timer. The timers can be configured with a frequency: Daily; Every 2 days; Every 3 days; Every 4 days; Every 5 days; Weekly; Every 2 weeks; Every 3 weeks; Every 4 weeks.

**6.4 LED spotlight:** In case of having installed led lights in your pool, use this menu to set the lighting.

**6.5** From this menu you can change the color of the lights in your pool. Select the length of the sign in seconds in Pulse length and press Next Program option to apply the pulse. Refer to your LED spotlight manual to set its different colors.

## 7. AUXILIARY RELAYS

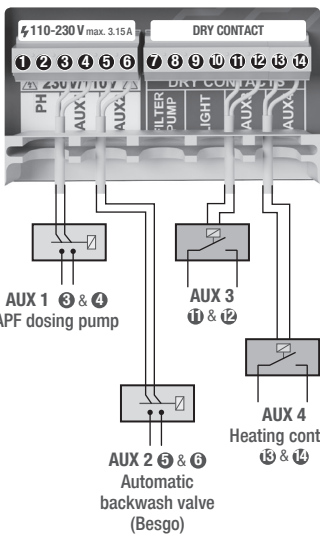

The auxiliary relays are configured by default. If you want to reassign the relays for other accessories, you must access the "Service Menu". Contact your authorized installer.

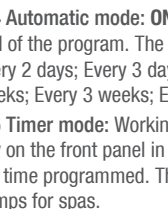
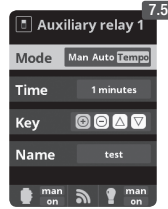
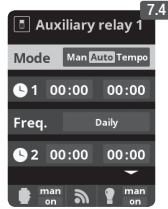
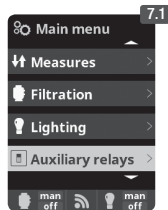

### 7.1 Auxiliary relays:

**7.2** It is possible to control up to 4 extra auxiliary relays (water features, fountains, automatic irrigation systems, built-in cleaning systems, air pumps for spas, garden lighting, etc.). This menu displays the relays which are still available on your device and allow configuration.

### 7.3 Manual mode (ON/OFF).

**7.4 Automatic mode: ON/OFF** according to a timer that adjust the start and end of the program. The timers can be configured with a frequency: Daily; Every 2 days; Every 3 days; Every 4 days; Every 5 days; Weekly; Every 2 weeks; Every 3 weeks; Every 4 weeks.

**7.5 Timer mode:** Working time is programmed in minutes. Each time the key on the front panel in relation to the relay is pressed, it will start up for the time programmed. This function is recommended for the timing of air pumps for spas.

**7.6 Rename relays:** It is possible to rename each auxiliary relay to suit the use you want to assign. By pressing the **plus/minus** keys, a pop-up keyboard will appear. Scroll up and down with the **up/down** keys and left to right with the **plus/minus** keys. To select a letter press the **OK**.

## 8. SYSTEM SETTINGS

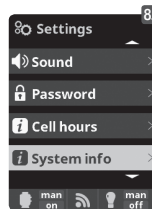
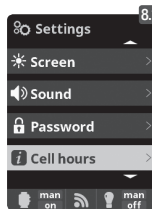
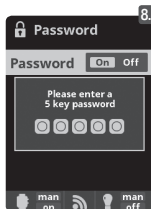
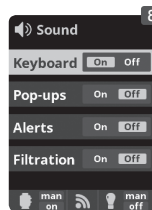
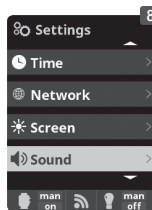
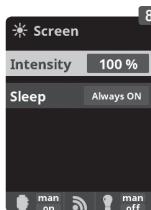
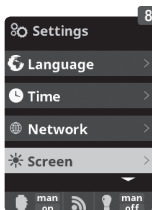
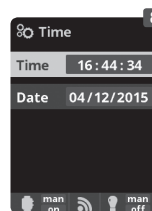
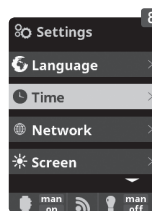
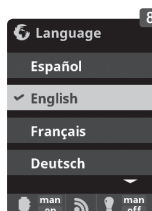
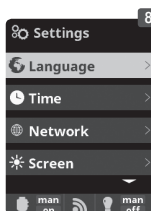
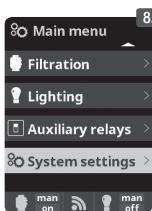

### 8.3 Setting of preferred language.

### 8.5 Setting of day and current time.

**8.7** Setting of the intensity of the display lighting (0-100%) and programming its **ON/OFF** time.

**8.9 Sound:** Programming of the system to emit sound for the functions: **Keyboard** (keys); **Notices** (pop-up message); **Alarms** (working alarm); **Filtration** (start of the filtration).

**8.11 Password:** Allows to protect the access to the user's menu by activating a password. To enter your password press a combination of 5 keys and the system will memorize. If you forget the password, there is a "master password". Ask your installer/provider.

**8.12 Cell hours:** The system memorizes the operation times of the different modules.

**8.14 System info:** Information about the available software version of the TFT display and the power module. It also shows the ID node which is necessary for the configuration of the WIFI connection of the system.



## 8.1 WIFI SETTINGS

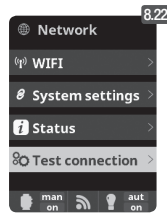
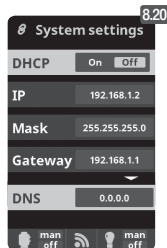
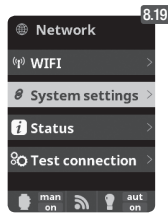
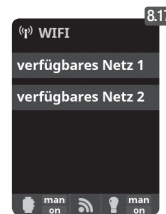
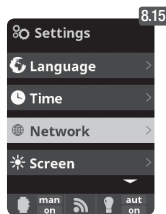
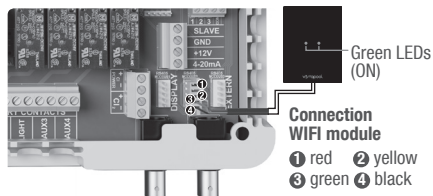

**8.15 Internet:** Once the WIFI module is connected, restart your unit. In the Settings menu will appear the Internet option.

**8.16 WIFI:** Select WIFI to scan the available networks accessible to the module. The search will be done automatically.

**8.17** Select the desired network accessible to the WIFI module.

**8.18** Enter the password in the pop-up keyboard. Scroll up and down with the **up/down** keys and left to right with the **plus/minus** keys. To select a letter press the **OK**.

**8.19 Configuration:** For a more detailed configuration enter this menu or contact your installer.

**8.21 Status:** Check the status of your connection.

**8.22 Test connection:** Check that your connection has been successfully established.

Once the WIFI module is connected to the network with both lights **ON**, enter in [www.vistapool.es](http://www.vistapool.es). Access the Register option and enter all the data requested. The unit ID code can be found on your device (see section 8. System Settings - screens 8.13 & 8.14). Upon completion of the process, you will have total control of your pool, will be able change parameters such as setpoints, filtration hours and turn **ON/OFF** any auxiliary relays.

## 9. SALINITY\*

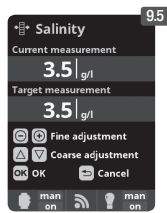

**9.1 Salinity:** The device shows a measurement of salt in water in g/l, as well as the date and water temperature of the last reading.

**9.2** To acknowledge this measure, press **OK** in Salinity in the Electrolysis/Hydrolysis menu (the process takes between 2 and 5 minutes - display 9.4). You can adjust the system measure using an external salt measurer (display 9.5).

**9.3** If you do not have a temperature probe, enter the value manually for greater accuracy. The lecture is influenced by many factors, like the water temperature or the pH. Remember to do the adjustment every 2-3 months.

\* **Attention:** Option only available for some models.

## 10. COVER

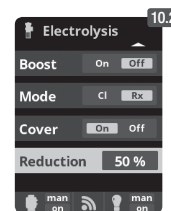
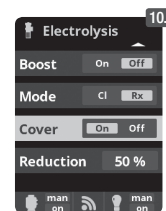
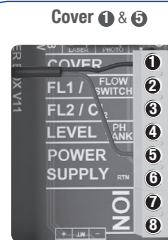

**10.1 Cover:** Connection of automatic cover.

**10.2 Reduction** of chlorine production in percent, when the pool cover is closed. With the cover closed is not necessary for the system to run at 100%. With this parameter, regulates the optimum amount of chlorine generation.

## 11. FLOW SWITCH

### Optional Flow switch

Mechanic security flow switch. Stops the hydrolysis/electrolysis and the dosing pumps if there is no water flow.

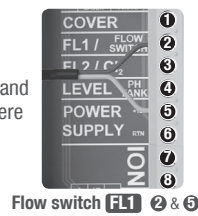

Flow switch FL1 2 & 6

It is possible to add an external flow switch to the system. Connect as shown in the image and contact your installer for activation. The titanium cell includes a gas flow sensor, you can combine both for better control.

## 12. LEVEL SENSOR (Tank)

Acid deposit level TANK 4 & 5



Connect a level sensor to your device so you can control at all times the volume available in the tanks of chemicals that your system commonly uses. Contact your installer/provider to activate the sensor. This way you can ensure that the dosing pumps never run out of product and doses in vacuo, avoiding possible damages.

## 13. VARIABLE SPEED PUMP

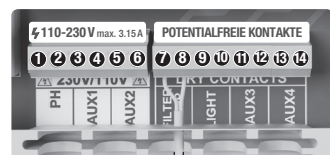

FILTER PUMP Filtration control 7 & 8



Variable Speed Pump

1 slow 2 medium 3 fast 4 common

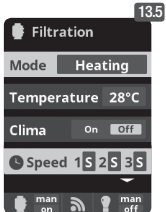
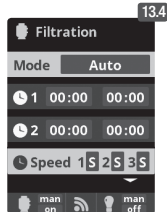
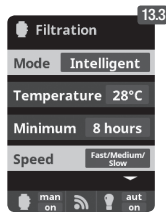
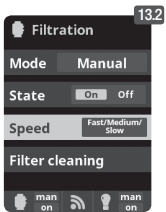
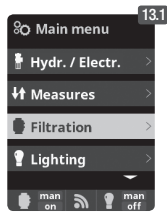

**13.1 Variable Speed Pump:** To install a Variable Speed Pump contact your installer.

**13.2 a 13.6** After connecting the pump, you can individually assign each filtration period a different speed

F: fast, M: medium and S: slow.



**13.7 Filter cleaning:** To clean the filter with a Variable Speed Pump, you should use the fastest speed.