

INSTALLATION GUIDE

1 DESCRIPTION

Station is a complete pool controller which doses pool-chemicals in order to maintain the pool water in perfect conditions. The base product controls the temperature, filtration periods, pool lighting and 4 additional relays. The base product is upgraded by adding the measurement and control of up to 4 water parameters. The management of the additional parameters can also be upgraded post-sales via "upgrade kits".



Electronic box



- 1 Main connection 220 V
- 2 ON/OFF switch
- 3 Fuse for device and cell 3.15 A
- 4 Fuse relays 3.15 A

Electrical connections of the electronic box

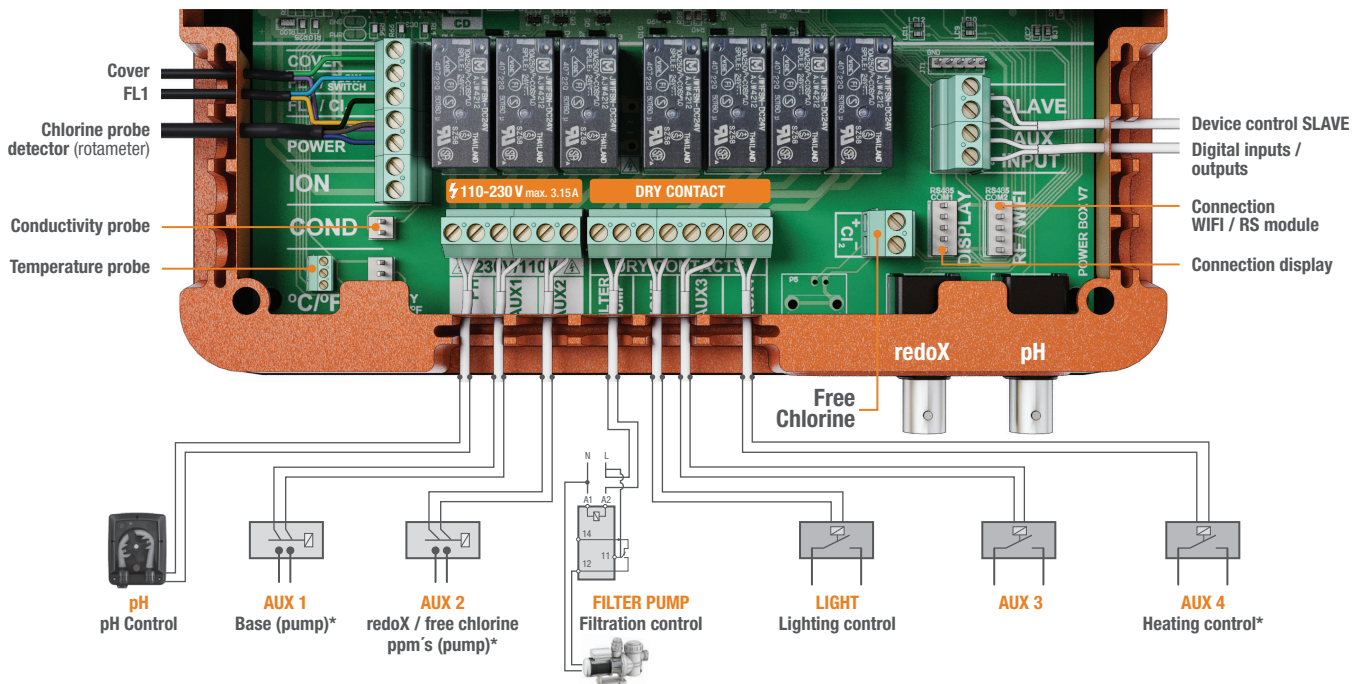

* An "Installer Menu" does exist for advanced functions. If you are an authorized installer, please ask your provider for the installers/service manual.

2 SYSTEM INSTALLATION

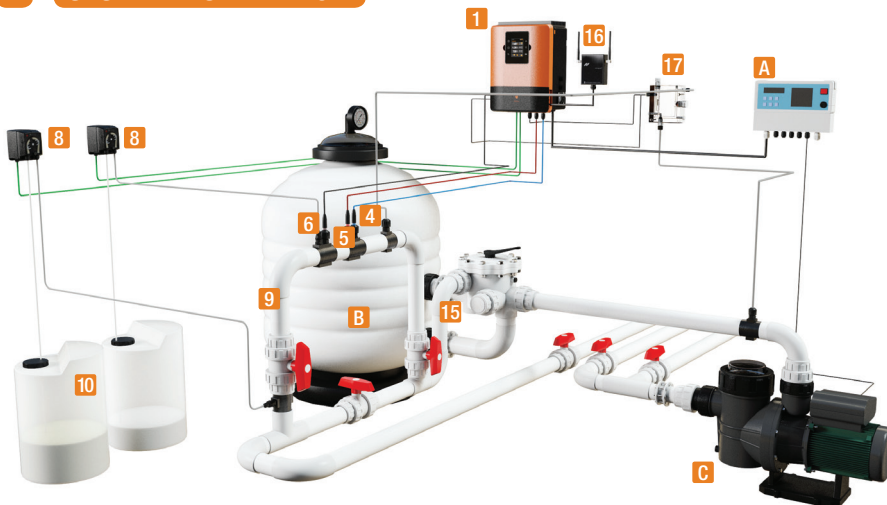

- A Filtration pump timer *
- B Silex / glass / diatom filter
- C Recirculation pump
- 1 Electronic box
- 4 pH probe (optional - for models with pH control)
- 5 redoX probe (optional - for models with redoX control)
- 6 Conductivity probe (optional - for models with conductivity control)
- 8 Acid dosing pump (optional - for models with pH control)
- 9 Acid injector (optional - for models with pH control)
- 10 Hydrochloric acid container (optional, for models with pH control, not supplied with unit)
- 15 Other pool equipment
- 16 Module RF or RF/WIFI or WIFI
- 17 Free chlorine control

! * Filtration control by external timer

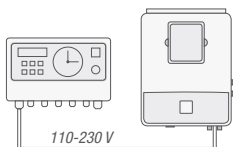

Filtration mode: "Manual/ON"

! * Filtration control by internal timer

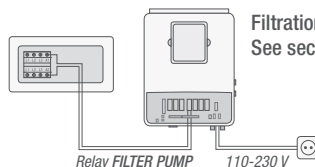

Filtration mode: See section 3.2

Optional automatic controls



pH control

Metering and control of the pH of the water.



redoX control

Metering and control of the redoX as check value of the free chlorine.



Free chlorine control

Metering and control in ppm of the free chlorine of the water.



Conductivity

Metering and control of the conductivity of the water in Msiemens.



Temperature

Temperature probe 0 - 100° C necessary to activate the filtration modes: heating / intelligent / smart.



Flow detector

Mechanic security flow switch. Stops the hydrolysis/electrolysis if there is no water flow.

3 FUNCTIONING OF THE SYSTEM

Main screen

Heating ON/OFF
Status of the auxiliar relays
Current time 12:30 25°C
Automatic measurements pH / redoX / free chlorine / conductivity (according to options)
State filtration relay (see section 3.2 - Filtration)
man Manual
aut Automatic
hea Heating
smt Smart
int Intelligent
Communication display – mother board
red indicates communication error
Water temperature
7.5 Setpoint pH maximum (acid control)
ON/OFF Function of acid pump and base pump
AL3 Maximum dosing time exceeded (⊖ to reset the alarm)
7.0 Setpoint pH minimum (base control)
ON/OFF Function of chlorine pump
FL 1 Flow alarm / FL 2 Error rotameter Cl₂
700 Setpoint redoX minimum
State relay lighting
man Manual / aut Automatic

- ⊕ PLUS key
Modify value/selection
- ⊖ MINUS key
Modify value/selection
- OK OK key
Select/confirm
- ⬆ UP key
Navigation up
- ⬇ DOWN key
Navigation down
- ↶ RETURN/ESCAPE key

3.1 Measures

1.1 Measures: Adjustment of setpoints and measuring probes.
1.2 Setpoints for each measurement.
1.3 Setting of setpoints.
1.4 Calibration of pH probe: Recommended every month during usage season.
1.5 Calibration with buffers (buffer solutions pH7 / pH10 / neutral): Follow the instructions which appear on the displays (fig. 1.6).
1.7 Manual calibration: Allows to adjust the probes at 1 point (without buffers) – only recommended to adjust small deviation in the readings.
1.8 Without removing the probe from the water, use the **plus/minus** keys to adjust the reading so it matches with your reference value (photometer or other measurement).
1.9 Calibration of the redoX probe: Recommended every 2 months during usage season.
1.10 Calibration with buffer (buffer liquid 465 mV): Follow the instructions which appear on the displays (fig. 1.11).
1.11
1.12 Manual calibration: Allows to adjust the probes at 1 point (without buffers) – only recommended to adjust small deviation in the readings.
1.13 Without removing the probe from the water, use the **plus/minus** keys to adjust the reading so it matches with your reference value (photometer or other measurement).
1.14
1.15 Temperature calibration: To set the difference between the measured value of the probe and the actual temperature, use the **plus/minus** and **up/down** keys. Set to the actual temperature of the probe and press OK.

3.2 Filtration



You can access the display "Filter cleaning" from any filtration mode. Once selected this function, press the OK key.

2.1 Filtration modes

2.2 Manual: Filtration can be switched ON and OFF manually.

2.3 Automatic (or with timer): In this mode the filtration switches ON/OFF according to 3 timers. The timers always work on daily bases.

2.4 Smart*: This mode uses, as a basis, the automatic or timer mode, with its 3 intervals of filtration, but adjusting the filtration time in function of the water temperature. For that reason 2 parameters of temperature are provided: The maximum temperature, from which on the filtration times will be the ones from the timer setting. The minimum temperature: below this value the filtration time will be reduced to 5 minutes, which is the minimum working time. Between these 2 temperatures the filtration times will climb linearly. There is an option to activate the antifreeze mode in which the filtration will start if the water temperature is below 2° C.

2.5 Timed heating with option of climatization*: This mode acts equally to the automatic mode, but besides it includes the option to work on a relay to control the temperature. The desired temperature is set in this menu, and the system works with a hysteresis of 1 degree (example: the setting temperature is 23° C, the system will activate itself when the temperature goes below 22° C and will not stop before it passes 23° C).

Clima OFF: The heating only works within the set filtration periods.

Clima ON: Keeps the filtration working when the filtration period is finished if the water temperature is below the setting temperature. When the setting temperature is reached the filtration and the heating will stop and will not switch on till the next programmed filtration period.

2.6 Intelligent*: In this mode the user has 2 working parameters to guaranty the desired water temperature with a minimum of filtration hours: You select the desired water temperature and the minimum filtration time (minimum of 2 hours and maximum of 24 hours). The device divides the selected "minimum filtration time" in 12 fragments which start up every 2 hours. If one of these fragments finishes, without the temperature reaching the desired level, the filtration/heating continues until the desired temperature is accomplished. In order to keep the filtration-electricity-cost to a minimum, this additional filtration time is subtracted from the following fragments of the "minimum filtration time". The first 10 minutes of each fragment will not be subtracted. Example (see diagram): Minimum temperature = 28°C and minimum filtration time = 12 hours.

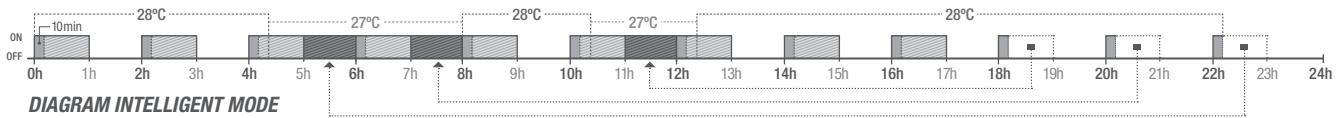

DIAGRAM INTELLIGENT MODE

2.7 Filter cleaning mode (and pool cleaning by suction): Use the up/down keys to activate or deactivate the filtration pump. The device will inform about the elapsed time from the moment of activation or deactivation. Follow the instructions of the filter manufacturer to execute an adequate filter cleaning.

* **Note:** Modes only visible if the option to use temperature and/or heating probe is activated in the "Installer Menu".

4.3 Lighting



3.1 Lighting

3.2 Manual mode (ON/OFF).

3.3 Automatic mode: Shuts lights ON/OFF according to a timer. The timers can be configured with a frequency: Daily; Every 2 days; Every 3 days; Every 4 days; Every 5 days; Weekly; Every 2 weeks; Every 3 weeks; Every 4 weeks.

3.4 Auxiliary relays



4.1 Auxiliary relays

4.2 It is possible to control up to 4 extra auxiliary relays (water features, fountains, automatic irrigation systems, built-in cleaning systems, air pumps for spas, garden lighting, etc.). This menu displays the relays which are still available on your device and allow configuration.

4.3 Manual mode (ON/OFF).

4.4 Automatic mode: ON/Off according to a timer. The timers can be configured with a frequency: Daily; Every 2 days; Every 3 days; Every 4 days; Every 5 days; Weekly; Every 2 weeks; Every 3 weeks; Every 4 weeks.

4.5 Timer mode: Working time is programmed in minutes. Each time the key on the front panel in relation to the relay is pressed, it will start up for the time programmed. This function is recommended for the timing of air pumps for spas.

3.5 Settings



5.3 Setting of preferred language.

5.5 Setting of day and current time.

5.7 Setting of the intensity of the display lighting (0-100%) and programming its ON and OFF time.

3.5 Settings (continuation)

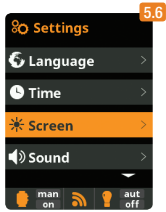

OK

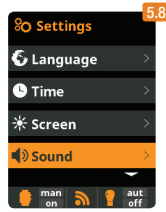
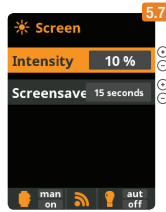

OK

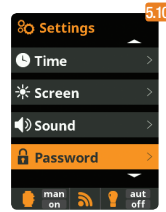
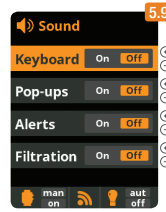

OK

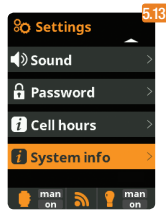
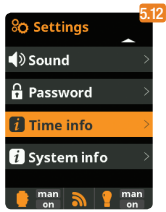

OK

2 X



- 5.9 Sound:** Programming of the system to emit sound for the functions: Keyboard (keys); Notices (pop-up message); Alarms (working alarm); Filtration (start of the filtration).
- 5.11 Password:** Allows to protect the access to the user's menu by activating a password. To enter your password press a combination of 5 keys and the system will memorize. If you forget the password, there is a "master password". Ask you installer/provider.
- 5.12 Time info:** The system memorizes the operation times of the different modules and they are displayed on the screen.
- 5.13 System info:** Information about the available software version of the TFT display and the power module. It also shows the ID node which is necessary for the configuration of the WIFI connection of the system.

4 SYSTEMS WITH redoX CONTROL

The redoX value advises us of the oxidation/reduction potential and is used to determine the level of water sterilization. The parameters or setpoints are the minimum/maximum accepted redoX levels before the titanium cell is connected/disconnected. Adjusting the ideal redoX level (setpoint) is the last step in the Station start up sequence. To find the optimum redoX levels for your pool follow these steps:

- 1 Connect the pool filtration system.
- 2 Add chlorine to the pool till a level of 1-1,5 ppm is achieved (approx. 1-1,5 gr/ m3 of water). pH levels should be between 7,2 - 7,5.
- 3 After 30 min. test the free chlorine levels in the pool (manual test kit DPD1) if the free chlorine level is between 0,8 - 1,0 ppm. Look at the redoX screen and memorize this level as the setpoint to CONNECT / DISCONNECT the chlorine pump.
- 4 The next day check free chlorine levels (manual test kit DPD1) and redoX. Raise / lower setpoint if necessary.
- 5 Remember to check the redoX set-point every 2-3 month and/or if the water parameters change (pH / temperature / conductivity).

5 MAINTENANCE

First days of maintenance

During the first 10-15 days your pool system will require more attention and the following care:

- 1 Make sure the pH remains on the ideal level (7,2 - 7,5). If the pH is unusually unstable and uses a lot of acid, check the alkalinity (recommended levels between 80 y 120 ppm).
- 2 The pool must be vacuumed and the skimmers cleaned whenever necessary to ensure perfect water conditions.

General maintenance

- 1 **DOSING PUMPS:** Check regularly to ensure that the container contains liquid to prevent the dosing pump of running dry. The dosing pump requires maintenance (SEE INSTRUCTIONS ON BOX).
- 2 **pH PROBES / redoX / CONDUCTIVITY:** Probes must be cleaned whenever necessary (check every 5-6 months). To clean the probe insert in distilled water (clear liquid). After each cleaning the probes must be calibrated. Also: the probes should never dry out and must be kept wet if stored (when emptying the pool for winterizing, make sure to store the measuring head in water).

Fortnightly checks

FREE CHLORINE 1,0 - 2,0 ppm
pH: 7,2 - 7,5

Monthly checks

TOTAL ALKALINITY (TAC) pH: 80 - 120 ppm
CYANURIC ACID 30 - 50 ppm

6 TROUBLESHOOTING

Blank display

- Check if ON/OFF switch is illuminated.
- Check the connection wire between display and motherboard.
- Check fuse of the device 3.15 A – it could have tripped due to overload.
- Check the power supply 110V/60Hz – 230V/50Hz.
- If problem persists contact TECHNICAL SERVICE

White flakes in the water

- The water is excessively hard and it is unbalanced.
- Balance the water and check the cell, proceeding to clean it if necessary.
- Put 1 small bag of flocculant in the skimmer and recirculate 24 hours.

Alarm AL3 and pH dosing pump stopped

- The maximum dosing time (standard 200 min.) is accomplished and the acid dosing pump stops in order to avoid the acidification of the water.
- To delete the message and to restart the metering press ESC (⊘). Do the following verifications in order to preclude errors on the device: Verify if the pH probe reading is correct (if not, calibrate the probe or substitute it with a new one); Verify if the acid/base deposit is full and if the dosing pump is working correctly; Verify the variable speed of the dosing pump.

WARNING

Keep chemical levels in pool as instructed in this manual.

EARTHING

All metallic components in the pool such as lamps, ladders, heat exchangers, drains or similar elements within 3 m from the pool (10 feet) must be connected to an earth below 37 Ohms. If using heat exchangers, we recommend them to be made of titanium.

SECURITY

To avoid accidents, children should not handle this product unless supervised by an adult. Children should be supervised at all times when in or near a spa, pool or jacuzzi.

